

# AFOLUX GEN II

AFL2-W15A-N270

Intel® Atom™ Solution

AFL2-W15A-L325

AMD 780E Solution

## 15.6" Wide Modular Expansion Panel PC

IEI designed a completely new modular architecture for its new AFOLUX GEN II Panel PCs. A variety of expansion module boards connecting through a common interface give it functional versatility. The AFOLUX GEN II services diverse applications and is especially suited for self-service and interactive environments.

**Expansion Module**



### Features

- **Modular All-in-One System**

Wide 15.6" all-in-one system is designed around its modularization architecture. Easy to expand and upgradeable functions through added modules increases system scalability and versatility.

- **Extraordinary Outlook**

Sleek flat-bezel design makes the screen stylish and easy to clean. Slim body with only a 5 cm depth ensures the system is perfect for any public environment.

- **Reliable Design**

IP64 compliant front panel protection resists water and dust invasion. Function modules based on board-to-board design ensuring system reliability for delivery and transportation applications.

## 5-in-1 Rich Expansion

The guiding principle behind the AFOLUX GEN II is the ability to add expansion modules to the system mainboard facilitating simple expansion for system storage, PCI Express, parallel, serial and USB interface functions.

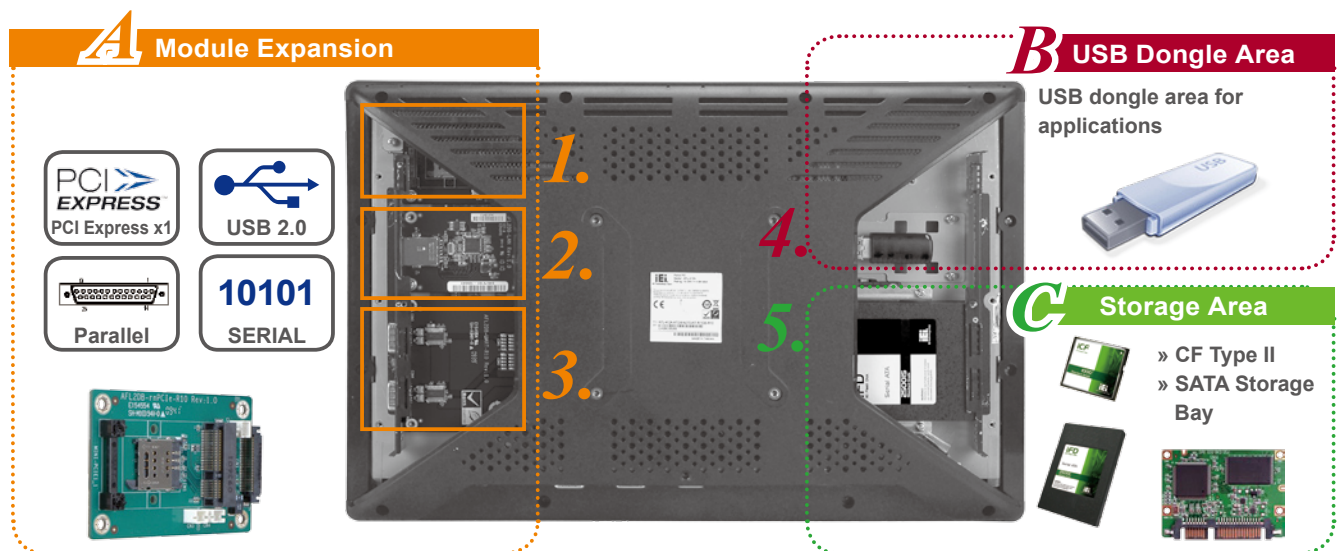

## A. Module Expansion

### Rear Left Side View

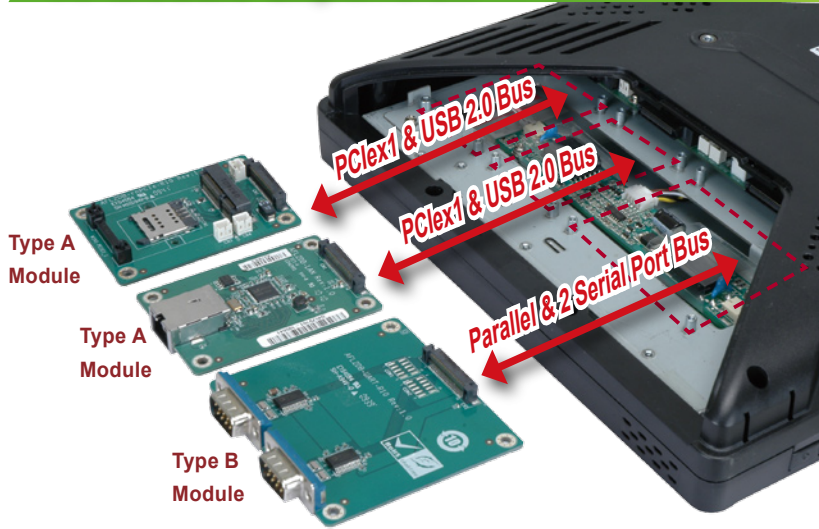

1. Easy to install function modules
  2. Small form factor function modules save warehouse space
  3. Faster distribution to your customers
  4. Customizable I/O bracket to fit different module board connectors
- Semi-off holes for one LAN port and two COM ports

## Optional Modules

### Type A Module

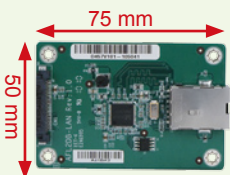

- **AFL2DB-MPCIE-R10**  
PCIe Mini Card Carrying Module

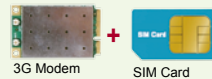

- **AFL2DB-LAN-R10**  
Giga Ethernet Module



- **AFL2DB-USB3-R10**  
USB 3.0 Module



- **AFL2DB-CPT4-R10**  
4-Channel Video Capture Module



### Type B Module

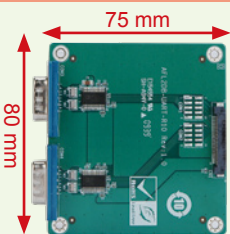

- **AFL2DB-UART-R10**  
Serial Extension Module



Function	Interface	IEI Module Board	Type
HSUPA 3.5G connection	PCIe Mini card	AFL2DB-MPCIE-R10 + Optional 3.5G modem card	A
DVBT/ATSC or hybrid TV tuner	PCIe Mini card	AFL2DB-MPCIE-R10 + Optional TV tuner card	A
Ethernet	PCIe x1	AFL2DB-LAN-R10	A
USB 3.0	PCIe x1	AFL2DB-USB3-R10	A
Video capture card (4 port)	PCIe x1	AFL2DB-CPT4-R10	A
Serial port	2 x Serial	AFL2DB-UART-R10	B

## B. Universal USB Dongle Area

### Rear Right Side View

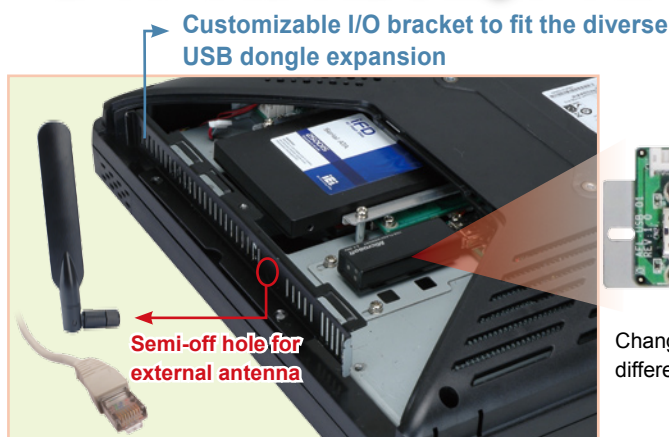

Reserved internal USB slot allows fast deployment of diverse USB dongles.

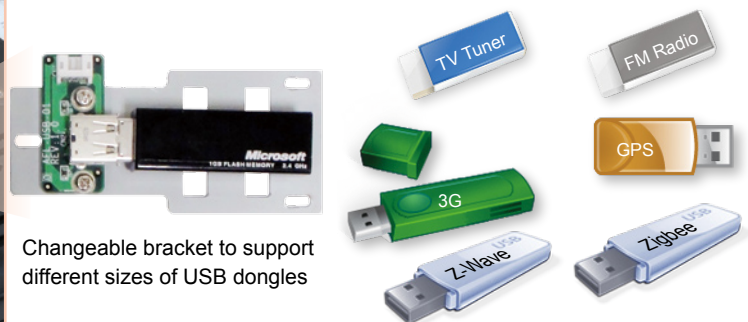

**AFL2-W15A-N270**

\* AFL2-W15A-L325 without USB dongle area



## C. Storage Area

## Rear Right Side View

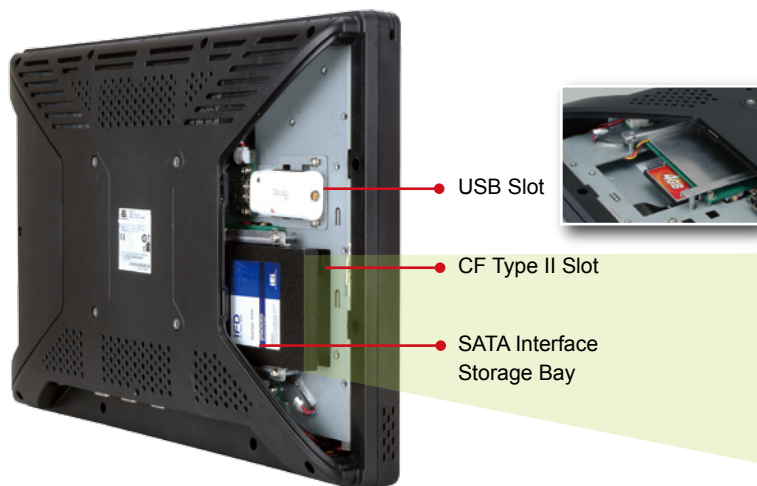

### Reliable Anti-Vibration SSD



#### 2.5" SATA SSD

- Vibration: 20 G (7~2000 MHz)
- Shock: 1500 G / 0.5 ms

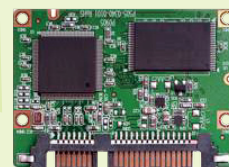

#### SATA SSD Module

- Capacity 8 GB ~ 32 GB
- Data Transfer Rate Up to 90 / 30 MB
- Power Supply: 5 V
- Power Consumption: <250 / 150 mA

## Diverse Performance Options

### • Reliable Fanless System-Intel® Atom™ Platform *Fanless*

High performance Intel® Atom™ CPU with low power consumption runs fast and stable for long-term usage.

### • Graphic Performance System-AMD 780E Platform

- Built-in MPEG2/H.264/AVC Full HD Decoder
- HDMI delivers the High Image Quality on the Second Display

The AFL-W15A-780E series has a high definition HDMI second display port. HDMI (High-Definition Multimedia Interface) is a compact audio/video interface for transmitting uncompressed digital data. It delivers high-definition video support at 1080p resolution which equals 1,920x1,080 pixels. It also supports industry standard EIA-861B video modes including 480p, 720p, 1080i, and 1080p.



About 50 feet



Performance	CPU	Memory	3D - Passmark Performance Test	3D - 3DMark 2006 v1.1.0	3DMark 2001 SE
Intel® 945GSE Atom N270 1.60GHz / 533MHz 512K/L2 Cache	254.2	228.1	83.7	109	2783
Intel® Atom D525 1.8GHz 1MB/L2 Cache	725.5	244.7	123.4	121	3089
AMD Sempron Processor 210U 1.50GHz (On board)	311.6	265.3	87.2	723	6020
AMD Athlon Neo X2 Dual Core L325 1.50GHz (On board)	613.9	235.2	92.1	882	7347

### 3DMark Performance comparison

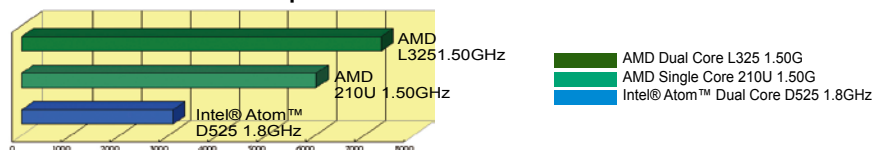

## Seamless Flat-Bezel Design

The AFOLUX GEN II adopts a flat glass bezel with projected capacitive or resistive touchscreen.

- Sleek and stylish design
- Perfect edge design prevents dust and water accumulation
- Easy to clean



Sleek & stylish

▲ Advanced Flat-Bezel Design

## Slim Body Optimizes Space Utilization

The AFOLUX GEN II packs a lot of features into an ultraslim design. Measuring at just over 54 mm and only 3.8 kg, its slim body and rich expansion capabilities are designed to fit your self-service applications.

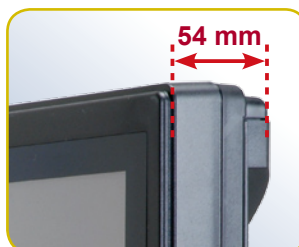

Slim Body

## Integrated EM / Mifare RFID Reader

The integrated RFID reader in the AFOLUX GEN II system allows for great efficiency, while the Mifare reader has read/write capabilities to update tag data in the field. Together these functions make the AFOLUX GEN II the most advanced interactive asset tracking and identification terminals.

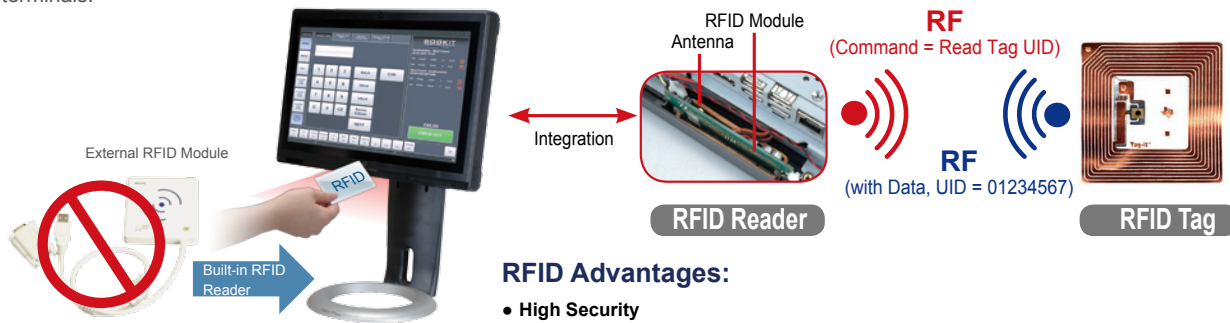

### RFID Specifications:

- Frequency: 125KHz or 13.56 MHz
- Reading distance: 5~7 cm
- Supports ISO 14443A Mifare® or EM standard

### RFID Advantages:

- **High Security**  
Each RFID tag contains an integrated chip with a unique permanent identification (UID) number burned-in during the manufacturing process to make counterfeiting difficult.
- **High Efficiency**  
Multiple tags can be read in parallel; no line of sight reading
- **High Durability**  
Less subject to environmental damage

## Diverse Wireless Connectivity

### • 802.11-b/g/n Wireless LAN

Integrated PIFA antenna on the AFOLUX GEN II ensures an uninterrupted wireless connection and provides up to IEEE 802.11n wide bandwidth operation. Frees cables and clutter from your workspace.



- Invisible antenna
- The data transfer rate of the IEEE 802.11n is 27 times than the 802.11b



### • Bluetooth V2.1+EDR

Preinstalled bluetooth module communicates with a wide range of electronic devices from PDAs and cellphones to barcode readers. Good transmission performance, greater than 20 m in free space.

## Video Intercom Device Ready

Ready for VoIP, door intercom, video conferencing and digital signage applications.

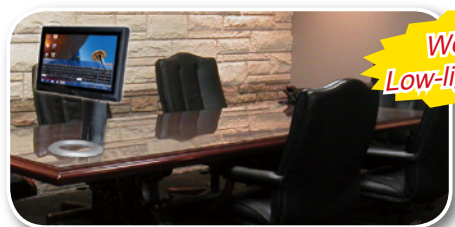

**Webcam with Low-light Capability**

- VGA resolution image sensor
- Video resolution: 1280x1024, 640x480, 352x288, 320x240, 176x144, 160x120.
- Frame rate: 640x480 @ 30fps max.
- Storage format of image: AVI
- Storage format of photograph: BMP, JPEG



# IEI Expansion System Concept

## Features:

- Reliable board to board connection
- IEI's self-defined module interface reduces synchronization between function and system

## Standard Connector Type Easy to Design Expansion Module

The AFOLUX GEN II motherboard utilizes a three 50-pin card-edge connector to connect the expansion module.

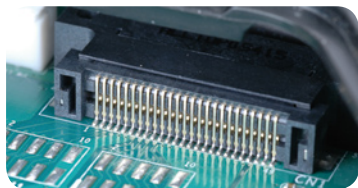

Connector Type: JAE KX15-50KLD\* or equivalent

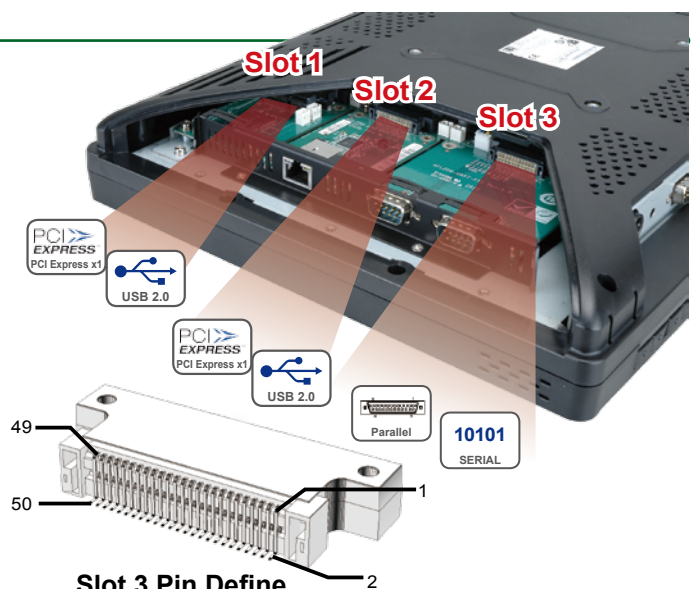

## Slot 1 and 2 Pins Define

Table 1: PCIe x 1 and USB Interface Signals

Pin	Signal	Pin	Signal
1	GND	2	GND
3	PETP1	4	PERP1
5	PETN1	6	PERN1
7	GND	8	GND
9	SMBCLK	10	CLK_PCIE_LAN2
11	SMBDATA	12	CLK_PCIE_LAN2#
13	GND	14	GND
15	PCIE_WAKE#	16	PCIRST#1
17	GND	18	GND
19	GND	20	USBD+
21	GND	22	USBD-
23	GND	24	GND
25	GND	26	GND
27	+1.5V_PCI	28	GND
29	+1.5V_PCI	30	VCC3_PCI
31	+1.5V_PCI	32	GND
33	GND	34	VCC3_PCI
35	GND	36	GND
37	VCC3	38	VCC3_PCI
39	VCC3	40	GND
41	GND	42	GND
43	GND	44	VCC5_PCI
45	GND	46	VCC5_PCI
47	VCC12_PCI (Reserved)	48	GND
49	VCC12_PCI (Reserved)	50	GND

\*pin 27, 29, 31: +1.5v -> max 2.1A  
 \*pin 30, 32, 38 : +3.3v -> max 2.1A  
 \*pin 44, 46 : +5v -> max 1.4A  
 \*pin 37, 39: +3.3v dual -> max 1.4A  
 \*pin 20, 22: not supported on slot 2  
 of AFL2-W15A-L325

## Slot 3 Pin Define

Table 2: Parallel and Serial Port Interface Signals

Pin	Signal	Pin	Signal
1	DCD-5	2	DSR-5
3	RXD-5	4	RTS-5
5	TXD-5	6	CTS-5
7	DTR-5	8	RI-5
9	GND	10	GND
11	GND	12	GND
13	DCD-6	14	DSR-6
15	RXD-6	16	RTS-6
17	TXD-6	18	CTS-6
19	DTR-6	20	RI-6
21	GND	22	GND
23	GND	24	GND
25	PD7	26	PD6
27	PD5	28	PD4
29	PD3	30	PD2
31	PD1	32	PD0
33	-STB	34	-AFD
35	-ERR	36	-INIT
37	-SLIN	38	-ACK
39	BUSY	40	PE
41	SLCT	42	GND
43	GND	44	GND
45	VCC5	46	VCC12
47	VCC5	48	VCC12
49	VCC5	50	VCC12

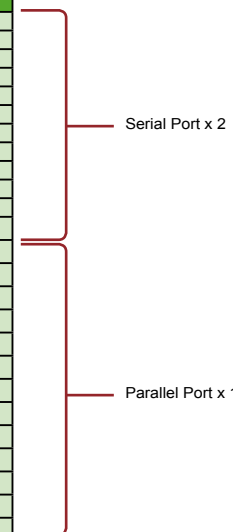

## Applications



Use one system in different markets!

HSUPA 3.5G

DVB/T/ATSC/Hybrid

UART  
Serial Port

Ethernet

USB 3.0

Video card

### Digital TV

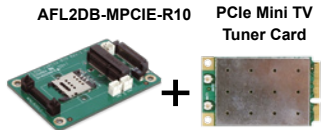

### 3G/3.75G

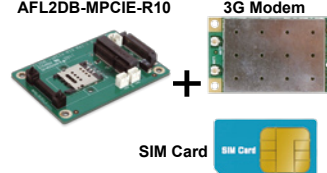

### 4-Port Video Capturing







Specifications

	Model	AFL2-W15A-N270	AFL2-W15A-L325
LCD Specifications	Size	Wide 15.6" TFT LCD	
	Resolution	1366 x 768	
	Brightness	250 cd/m <sup>2</sup>	
	Contrast Ratio	500:1	
	LCD Color	16.2 M	
	Pixel Pitch (mm)	0.252(H) x 0.252(V)	
	Viewing Angle (H-V)	110°(H) / 85°(V)	
	Backlight MTBF	50000 hrs	
System	CPU	Intel® Atom™ processor N270 1.6 GHz CPU	AMD ASB1 L325 dual core 1.5 GHz CPU
	Chipset	Intel® 945GSE + ICH7M	AMD 780E + SB710
	RAM	Support one 400 MHz or 533 MHz DDR2 SO-DIMM (2 GB max.)	Support two 400 MHz or 533 MHz DDR2 SO-DIMM (4 GB max.)
	SSD	CF Type II	CF Type II
	HDD	1 x 2.5" SATA HDD Bay	1 x 2.5" SATA HDD Bay
	Watchdog Timer	Software programmable supports 1~255 sec. system reset	Software programmable supports 1~255 sec. system reset
	Input / Output	1 x RS-232 COM port 1 x RS-232/422/485 COM port 1 x RJ-45 for GbE LAN 2 x USB 2.0 1 x Power switch 1 x Reset button 1 x Audio port (Line out) 1 x VGA 1 x Power jack 1 x External SATA 1 x 8-bit digital I/O, 4-bit input/4-bit output (optional)	1 x RS-232 COM port 1 x RS-232/422/485 COM port 1 x RJ-45 for GbE LAN 4 x USB 2.0 1 x Power switch 1 x Reset button 1 x Audio port (Line out) 1 x VGA 1 x Power jack 1 x HDMI 1 x 8-bit digital I/O, 4-bit input/4-bit output (optional)
	Expansion Interface	2 x PCIe by 1, 1 x USB dongle, 1 x Parallel port expansion, 2 x Serial port expansion	2 x PCIe by 1, 1 x Parallel port expansion, 2 x Serial port expansion * USB signal not Support on slot 2
Other Features	Audio	AMP 1.5 W + 1.5 W (internal speaker)	
	Camera	1.3 M pixels with low light function	
	RFID Reader	EM 125 KHz or Mifare 13.56 MHz card reader (optional)	
	OSD Function	LCD on/off, brightness up/down, volume up/down	
	Ambient light sensor	Yes	
	Infrared Remote Controller	LCD on/off, brightness up/down, volume up/down	
	Touch Screen	Resistive type 5-wire flat touch window	
Wireless	1 x Optional HSUPA mobile module (PCIe mini card interface) (Support GSM 850, EGSM 900, DCS 1800 & 1900) 1 x Wireless LAN 802.11 b/g/n module (internal PCIe mini card interface) 1 x Bluetooth function (internal USB interface, bluetooth V2.1+EDR) Supported Bands *HSPA/UMTS — 800/850/900/1900/2100 MHz *Quad-band EDGE/GPRS/GSM — 850/900/1800/1900 MHz *Dual-band EV-DO/CDMA — 800/1900 MHz		
Physical	Construction Front Panel	ABS + PC plastic front frame	
	Mounting	VESA 100 mm x 100mm	
	Color	Black C	
	Dimensions (mm)	400(W) x 267(H) x 54(D)	
	Weight (N/G)	3.8 kg	
Environment	Temperature (°C)	Operation: -10°C ~ 50°C, Storage: -20°C ~ 60°C	
	IP Level	Front panel IP64	
	Safety & EMI	CE / FCC / CB / CCC	
Power	Power Supply	60W power adapter Input: 90VAC~264VAC, 50/60 Hz Output: 12VDC	84W power adapter Input: 90VAC~264VAC, 50/60Hz Output: 12VDC
	Power Requirement	12VDC	
	Power Consumption	51W	

# I/O Interface

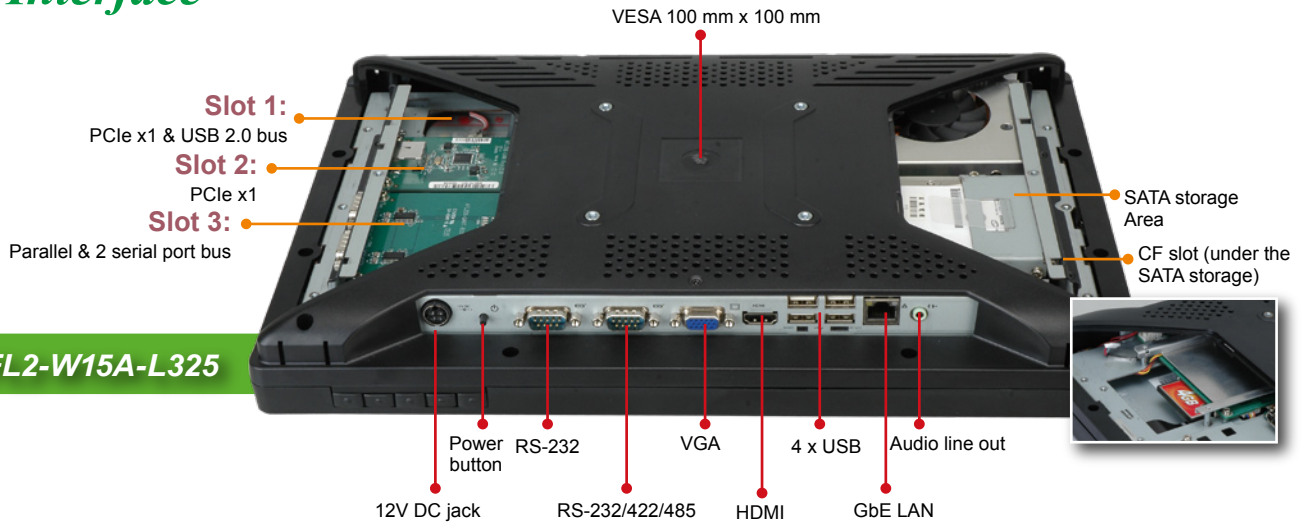

**AFL2-W15A-L325**

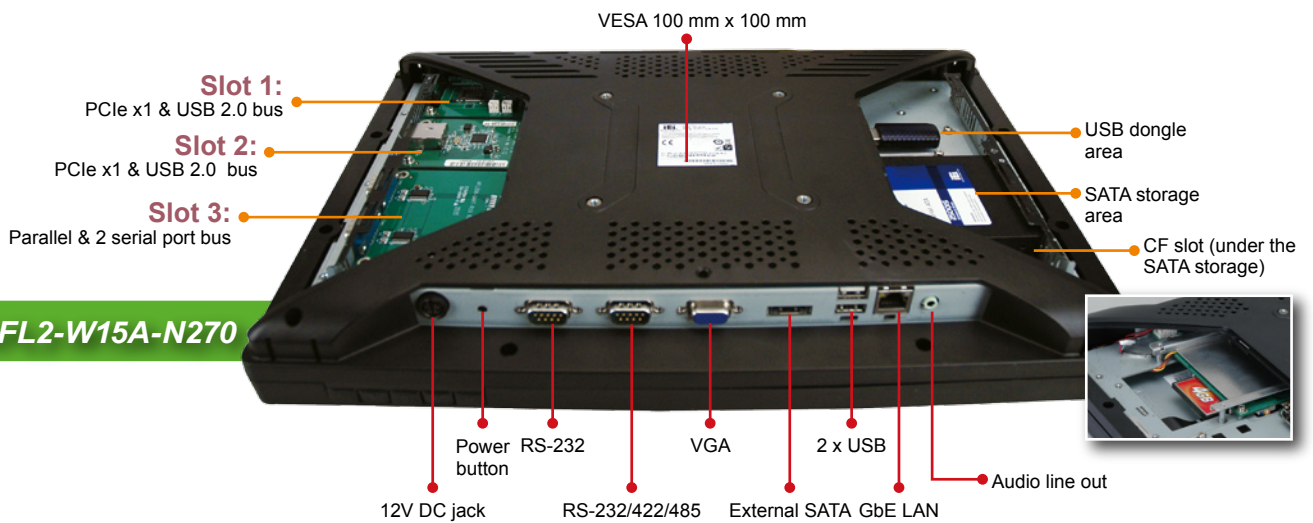

**AFL2-W15A-N270**

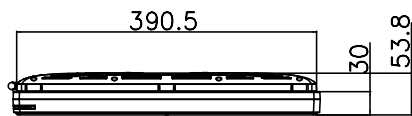

**AFL2-W15A**  
Dimensions (Unit: mm)

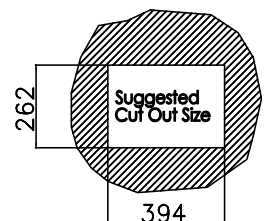
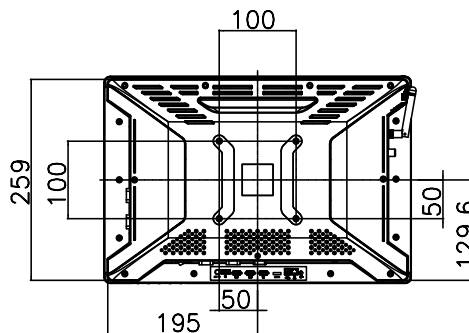
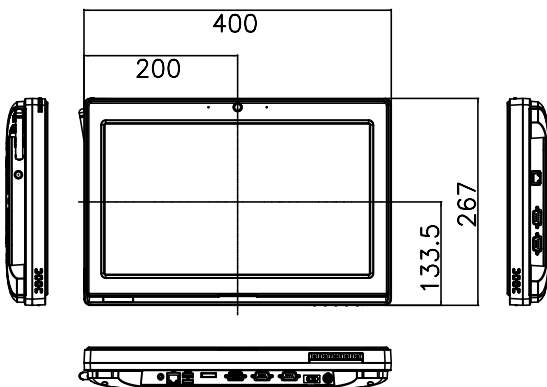

### Optional Kit

Options		AFL2-W15A-N270/R (Resistive type touch)	AFL2-W15A-780E/R (Resistive type touch)
Panel Mounting Kit		AFL2PK-W15A-R10	
Wall Mounting Kit		AFLWK-19 / AFLWK-19B	
ARM		ARM-11-RS / ARM-31-RS	
STAND		STAND-A19 / STAND-B19 / STAND-C19 / STAND-210-R11	
OS	Win CE 6.0	AFL2CF-W15-N270-CE060-R10 (128 MB CF card)	--
	Win XPE	AFL2CF-W15-N270-XPE-R10 (1 GB CF card)	AFL2CF-W15-L325-XPE-R10 (1 GB CF card)
	Linux	AFL2CF-W15-N270-LNX-R10 (2 GB CF card)	AFL2CF-W15-L325-LNX-R10 (2 GB CF card)
	Win 7	AFL2CF-W15-N270-WES7E-R10 (2 GB CF card)	AFL2CF-W15-780-WES7E-R10 (2 GB CF card)
AFL2SD-W15-N270-WES7E-R10 (4 GB SATA SSD module)		AFL2SD-W15-780-WES7E-R10 (4 GB SATA SSD module)	
DC 12 V Input UPS		AUPS-B10-R10 (VESA 100, DC 12 V input, 12 V output 100 W UPS module with 3800 mAh)	
DC 9~36 V Input UPS		AUPS-B20-R10 (VESA 100, DC 9~36 V input, 12 V output 100 W UPS module with 3800 mAh)	

### Packing List

Item	P/N	Q'ty	Specifications
Touch Pen	43125-0002C0-00-RS	1	
Power Adapter	63000-FSP060DBAB1554-RS (for Intel® N270 platform)	1	90-264 VAC input , 12 VDC output , 60W
	63000-FSP084DMBA1308-RS (for AMD L325 platform)		90-264 VAC input , 12 VDC output , 84W
Power Cord	32000-000002-RS	1	1750 mm; European standard
User's Manual CD ROM	7B000-000087-RS	1	
Screws	44013-030041-RS	4	
Remote Controller	7Z000-8T00320ICP05G-RS	1	



#### Touch Stylus Pen

Model No.:43125-0002C0-00-RS Description:

- 1) With special material
  - 2) Combined soft rubber with anti-oxidative plastic material
  - 3) Durable and flexible
  - 4) Particularly designed for AFOLUX GEN II touch Pen
- Length: 140mm

### Ordering Information

Resistive Type Touch		
Intel® Atom™	AFL2-W15A-N270/R/1G-R10	15.6" 250cd/m² WXGA+ fanless panel PC with Intel® Atom™ N270 1.6 GHz, 802.11b/g/n wireless module, bluetooth module, resistive touch screen, 1.3 M camera, microphone, 1GB DDR2 RAM, RoHS
	AFL2-W15A-N270/R-EM/1G-R10	15.6" 250cd/m² WXGA+ fanless panel PC with Intel® Atom™ N270 1.6 GHz, 802.11b/g/n wireless module, bluetooth module, resistive touch screen, 1.3M camera, microphone, 1GB DDR2 RAM, EM card reader
	AFL2-W15A-N270/R-MF/1G-R10	15.6" 250cd/m² WXGA+ fanless panel PC with Intel® Atom™ N270 1.6 GHz, 802.11b/g/n wireless module, bluetooth module, resistive touch screen, 1.3 M camera, microphone, 1 GB DDR2 RAM, Mifare card reader
AMD 780E	AFL2-W15A-L325/R/1G-R10	15.6" 250cd/m² WXGA+ panel PC with AMD 780E + L325 dual core 1.5 GHz CPU, 802.11b/g/n wireless module, bluetooth module, resistive touch screen, 1.3 M camera, microphone, 1GB DDR2 RAM, RoHS
	AFL2-W15A-L325/R-EM/1G-R10	15.6" 250cd/m² WXGA+ panel PC with AMD 780E + L325 dual core 1.5GHz CPU, 802.11b/g/n wireless module, bluetooth module, resistive touch screen, 1.3M camera, microphone, 1GB DDR2 RAM, EM card reader
	AFL2-W15A-L325/R-MF/1G-R10	15.6" 250cd/m² WXGA+ panel PC with AMD 780E + L325 dual core 1.5 GHz CPU, 802.11b/g/n wireless module, bluetooth module, resistive touch screen, 1.3 M camera,microphone, 1GB DDR2 RAM, Mifare card reader

### Optional Module

Model Name	AFL2DB-MPCIE-R10	AFL2DB-UART-R10	AFL2DB-LAN-R10	AFL2DB-USB3-R10	AFL2DB-CPT4-R10
Interface	PCIe x 1	UART	PCIe x 1	PCIe x 1	PCIe x 1
Board size (mm)	50 x 75	80 x 75	50 x 75	50 x 75	50 x 75
Specifications	Support full size PCIe mini card slot and standard SIM card socket	Two DB9 RS-232 interface	Cotroller: RTL8111CP Connection rate: one port 10/100/1000Base-T (RJ-45)	Host Controller: Fresco FL1000G Connction rate: USB2.0 (max. 480Mbps) / USB3.0 (max. 5Gbps) USB power output: DC +5V @ 900mA (max.)	4 channel video capture with 4 BNC inputs. Video resolution - NTSC/PAL: D1, Dalf-D1, CIF Total recording rate: 120fps (NTSC), 100fps (PAL)
OS support	Windows 7, Windows XP	Windows 7, Windows XP	Windows 7, Windows XP, Linux driver for kernel 2.6.	Windows 7, Windows XP	Windows 7, Windows XP

\* Packing with one video capture card and one DB9 to 4 BNC connector cable