

PICMG 1.3 Passive Backplane

Selection Guide

PAC series wall-mount Chassis

4U/5U Rack-mount Chassis

1U/2U Rack-mount Chassis

PICMG1.3 (PCIe+PCI)	Model	PE-2SD1	PE-2SD2	PE-4S	PE-4S2	PE-4S3	PE-5S	PE-5S2	PE-6S	PE-6S2	PE-6S3	PE-6SD	PE-6SD2	PE-6SD3
Total Slot		2	2	4	4	4	5	5	6	6	6	5	5	5
Expansion Slots	PCIe Slots	x16 *	1	1	1	1	1	1	1	1	1	1	1	1
		x4			1	1		1		1	1			1
		x1												
	PCI-X Slots					2			2		3		2	2
	PCI Slots		1	1	2		2	3	2	3	1	3	1	2
USB Connectors by Pin Header		4	4	4	4	4	4	4	4	4	4	4	4	4
PSU TYPE		24+4 PIN ATX	24+4 PIN ATX	24+4 PIN ATX	24+4 PIN ATX	24+4 PIN ATX	24+4 PIN ATX	24+4 PIN ATX	24+4 PIN ATX	24+4 PIN ATX	24+4 PIN ATX	24+4 PIN ATX	24+4 PIN ATX	24+4 PIN ATX
Chassis		N/A	N/A	PAC-42GF-R20 PACO-504F	PAC-42GF-R20 PACO-504F	PAC-42GF-R20 PACO-504F	RACK-500G-R20	RACK-500G-R20	RACK-305G-R20 RACK-360G-R20 RACK-814G-R20 RACK-3000G-R20 PAC-1700G-R20 PAC-25G-R20	24+4 PIN ATX	PAC-106G-R20 *1 PAC-107G-R20 *1 PAC-1000G-R20 PACO-506F	RACK-221G RACK-2100G	RACK-221G RACK-2100G	RACK-221G RACK-2100G
Note		1U Type	1U Type									2U Type	2U Type	2U Type

PICMG1.3 (PCIe+PCI)	Model	PE-7S	PE-7S2	PE-8S	PE-9S	PE-10S	PE-10S2	PE-13SD	PE-16SQ	PXE-12S	PXE-13S	PXE-19S	PXE-19S2
Total Slot		7	7	8	9	10	10	13	16	12	13	19	19
Expansion Slots	PCIe Slots	x16 *	1	1	1	1	1	1/1	1/1/1/1	1	1	1	1
		x4							1/0	1/1/1/1			
		x1	2	4	3	4	4	4	0/4	0		3	1
	PCI-X Slots									6			
	PCI Slots	3	1	3	3	4	4	2/2	1/1/1/1	4	8	16	16
USB Connectors by Pin Header		4	4	4	4	4	4	8	4/4/4/4	4	4	4	4
PSU TYPE		24+4 PIN ATX	24+4 PIN ATX	24+4 PIN ATX	24+4 PIN ATX	24+4 PIN ATX	24+4 PIN ATX	Dual 24+4 PIN ATX	Three 20+4 Pin ATX One 24+4-pin ATX	24+4 PIN ATX	24+4 PIN ATX	24+4 PIN ATX	24+4 PIN ATX
Chassis		PAC-1700G-R20	PAC-1700G-R20	PAC-125G-R20	N/A	RACK-305G-R20 RACK-360G-R20 RACK-814G-R20 RACK-3000G-R20	RACK-3000G-R20 RACK-305G-R20 RACK-360G-R20 RACK-814G-R20	RACK-3000G-R20 RACK-305G-R20 RACK-360G-R20 RACK-814G-R20	RACK-4000-R20	RACK-3000G-R20 RACK-305G-R20 RACK-360G-R20 RACK-814G-R20	RACK-3000G-R20 RACK-305G-R20 RACK-360G-R20 RACK-814G-R20	3200G-R20 RACK-3035G-R20	3200G-R20 RACK-3035G-R20
Note								Dual System Backplane	Quad System Backplane	PCIe to PCI-X Bridge backplane	PCIe to PCI Bridge backplane		

*1: When using a PCIe x16 add-on card, the length of the card must not exceed 167mm or 6.57inches.

IEI Graphic Grade Backplane Solution

Graphic centric backplane targets at applications which concerning system speed and performance. It has higher performance over cost ratio than previous PICMG1.0 solution.

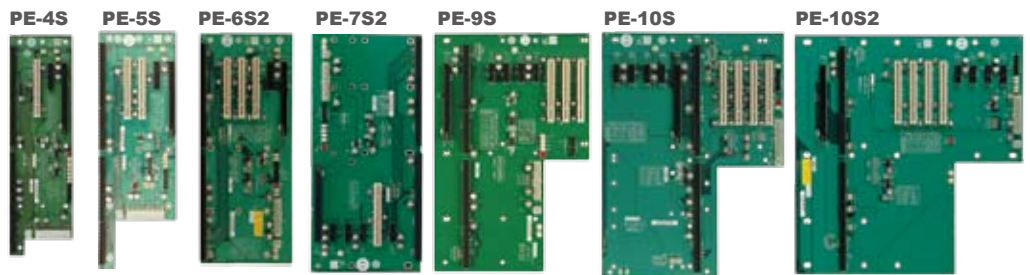
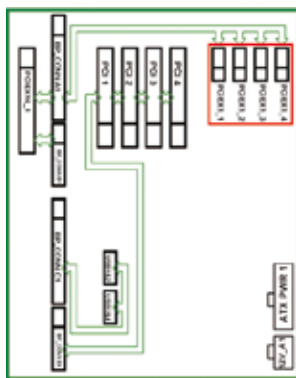

- 20 PCIe Lanes Total
- One PCIe x16 Slot
- Up to four PCIe x1 or One PCIe x4 Slot
- Up to four Local PCI Slots (w/o Bridge)

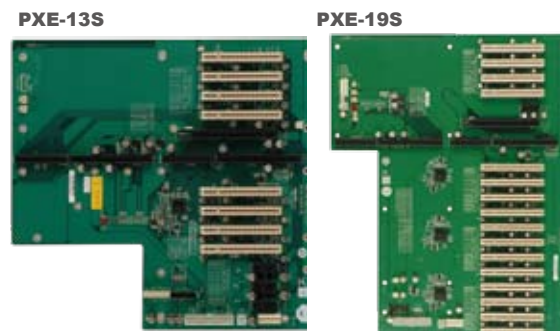
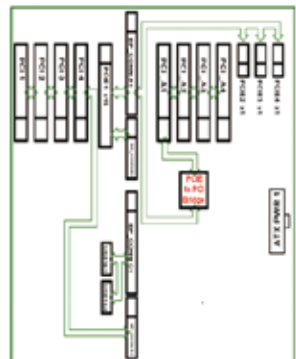

- 20 PCIe Lanes Total
- One PCIe x16 Slot
- Up to Four PCIe x1 Slots
- PCI Slots Expandable via PCIe to PCI Bridge

PE-2SD1-R10

NEW!!

Ready for 1U system!

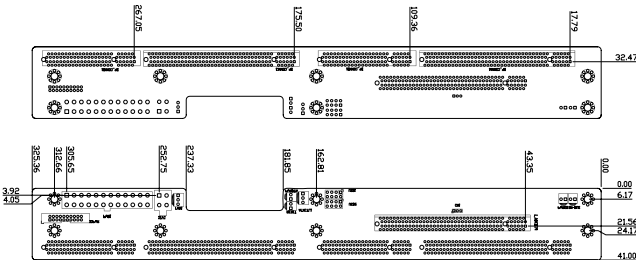

Ordering Information

- PE-2SD1-R10 1U chassis backplane with one PCIe x16 slot

PE-2SD2-R10

NEW!!

Ready for 1U system!

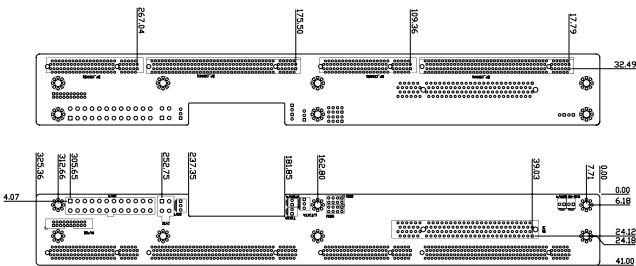

Ordering Information

- PE-2SD2-R10 1U chassis backplane with one PCI slot

PE-4S-R40

Mounting holes compatible with PCI-4S

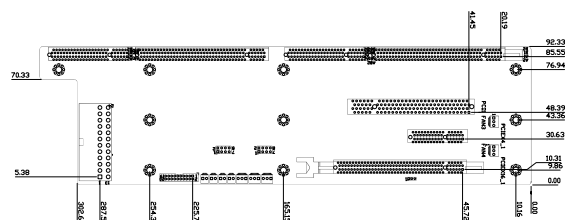

Ordering Information

- PE-4S-R40 4-slot backplane with 1 PCIe x16 slot, 1 PCIe x4 slot and 1 PCI slot
- PAC-42GF-R20 4-slot full-size industrial chassis
- PACO-504F 4-slot full-size industrial chassis

PE-4S2-R40

Mounting holes compatible with PCI-4S

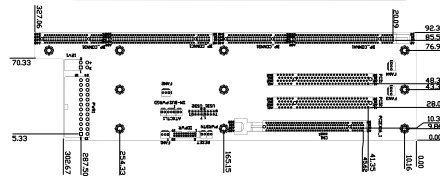

Ordering Information

- PE-4S2-R40 4-slot backplane with 1 PCIe x16 slot and 2 PCI slots
- PAC-42GF-R20 4-slot full-size industrial chassis
- PACO-504F 4-slot full-size industrial chassis

PE-4S3-R40

Mounting holes compatible with PCI-4S

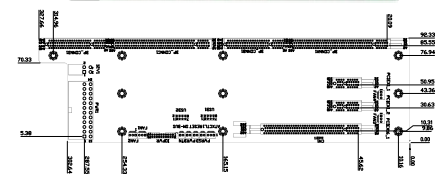

Ordering Information

- PE-4S3-R40 4-slot backplane with 1 PCIe x16 slot and 2 PCIe x1 slots.
- PAC-42GF-R20 4-slot full-size industrial chassis
- PACO-504F 4-slot full-size industrial chassis

PE-5S-R40

Mounting holes compatible with PCI-5S

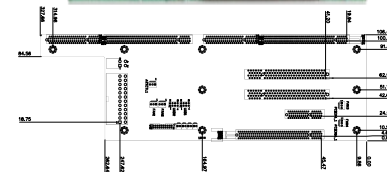

Ordering Information

- PE-5S-R40 5-slot backplane with 1 PCIe x16 slot, 1 PCIe x4 slot and 2 PCI slots
- RACK-500G-R20 5-slot full-size industrial chassis

PE-5S2-R40

Mounting holes compatible with PCI-5S

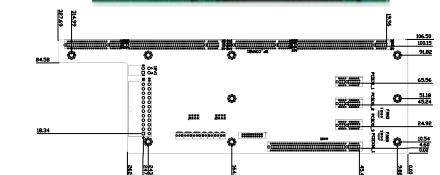

Ordering Information

- PE-5S2-R40 5-slot backplane with 1 PCIe x16 slot and 3 PCIe x1 slots
- RACK-500G-R20 5-slot full-size industrial chassis

PE-6S-R41

Mounting holes compatible with PCI-7S

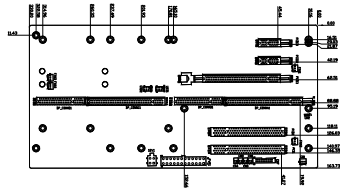
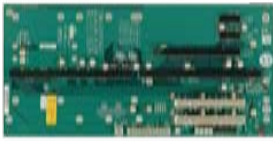

Ordering Information

- PE-6S-R41 6-slot backplane with 1 PCIe x16 slot, 2 PCIe x1 slots and 2 PCI slots
- RACK-305G-R20 4U rack-mount industrial chassis
- RACK-360G-R20 4U rack-mount industrial chassis
- RACK-814G-R20 4U rack-mount industrial chassis
- RACK-3000G-R20 4U rack-mount industrial chassis
- PAC-1700G-R20 7-slot full-size industrial chassis
- PAC-125G-R20 10-slot full-size industrial chassis

PE-6S2-R40

Mounting holes compatible with PCI-6S

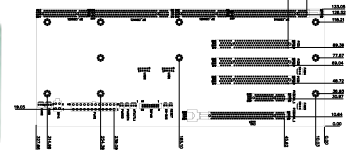

Ordering Information

- PE-6S2-R40 6-slot backplane with 1 PCIe x16 slot, 1 PCIe x4 slot and 3 PCI slots
 - PAC-106G-R20 *1 6-slot full-size industrial chassis
 - PAC-107G-R20 *1 6-slot full-size industrial chassis
 - PAC-1000G-R20 6-slot full-size industrial chassis
 - PACO-506F 6-slot full-size industrial chassis
- *1: When using a PCIe x16 add-on card, the length of the card must not exceed 167mm or 6.57inches.

PE-6SD-R40

Mounting holes compatible with PCI-6SD

2U Type

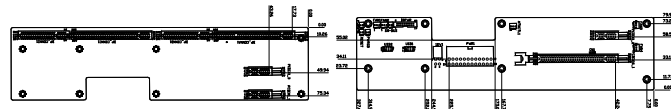

Ordering Information

- PE-6SD-R40 5-slot backplane with 1 PCIe x16 slot and 3 PCIe x1 slots
- RACK-221G 6-slot full-size industrial chassis
- RACK-2100G 6-slot full-size industrial chassis

PE-6S3-R40

Mounting holes compatible with PCI-6S

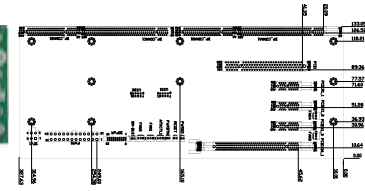

Ordering Information

- PE-6S3-R40 6-slot backplane with 1 PCIe x16 slot, 3 PCIe x1 slots and 1 PCI slot
 - PAC-106G-R20 *1 6-slot full-size industrial chassis
 - PAC-107G-R20 *1 6-slot full-size industrial chassis
 - PAC-1000G 6-slot full-size industrial chassis
 - PACO-506F 6-slot full-size industrial chassis
- *1: When using a PCIe x16 add-on card, the length of the card must not exceed 167mm or 6.57inches.

PE-6SD2-R40

Mounting holes compatible with PCI-6SD

2U Type

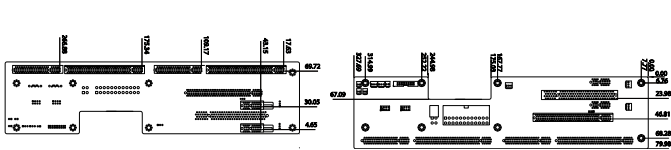

Ordering Information

- PE-6SD2-R40 5-slot backplane with 1 PCIe x16 slot, 2 PCIe x1 slots and 1 PCI slot
- RACK-221G 6-slot full-size industrial chassis
- RACK-2100G 6-slot full-size industrial chassis

PE-7S-R40

Mounting holes compatible with PCI-7S

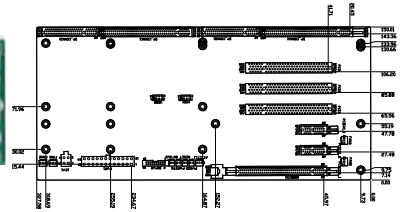

Ordering Information

- PE-7S-R40 7-slot backplane with 1 PCIe x16 slot, 2 PCIe x1 slots and 3 PCI slots
- PAC-1700G-R20 7-slot full-size industrial chassis

PE-6SD3-R40

Mounting holes compatible with PCI-6SD

2U Type

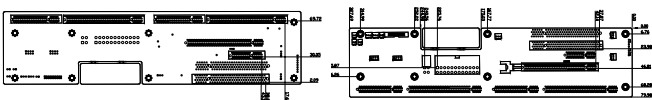

Ordering Information

- PE-6SD3-R40 5-slot backplane with 1 PCIe x16 slot, 1 PCIe x4 slots and 2 PCI slots
- RACK-221G 6-slot full-size industrial chassis
- RACK-2100G 6-slot full-size industrial chassis

PE-7S2-R40

Mounting holes compatible with PCI-7S

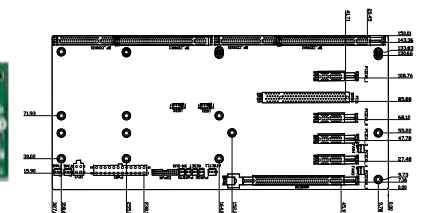

Ordering Information

- PE-7S2-R40 7-slot backplane with 1 PCIe x16 slot and 4 PCIe x1 slots and 1 PCI slot
- PAC-1700G-R20 7-slot full-size industrial chassis

PE-8S-R40

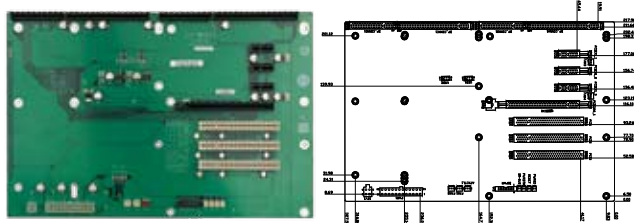

Ordering Information

- PE-8S-R40 8-slot backplane with 1 PCIe x16 slots, 3 PCI x1 slots and 3 PCI slots
- PAC-125G-R20 10-slot full-size industrial chassis

PE-10S-R40

Mounting holes compatible with PCI-14S

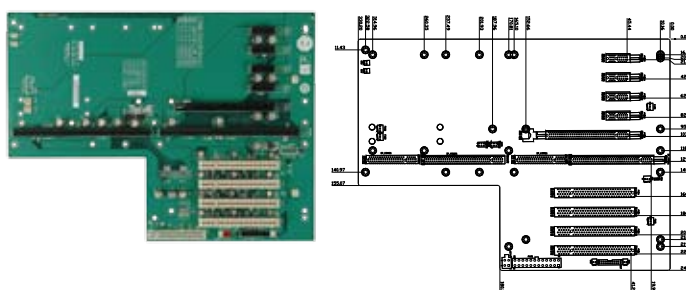

Ordering Information

- PE-10S-R40 10-slot backplane with 1 PCIe x16 slots, 4 PCI x1 slots and 4 PCI slots
- RACK-305G-R20 4U rack-mount industrial chassis
- RACK-360G-R20 4U rack-mount industrial chassis
- RACK-814G-R20 4U rack-mount industrial chassis
- RACK-3000G-R20 4U rack-mount industrial chassis

PE-9S-R40

Mounting holes compatible with PCI-10S2

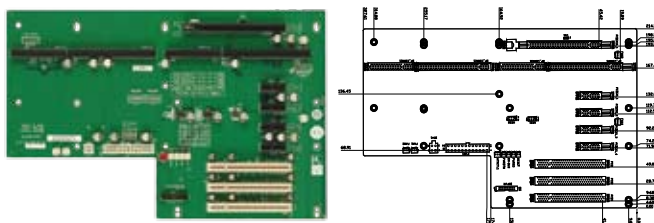

Ordering Information

- PE-9S-R40 9-slot backplane with 1 PCIe x16 slot, 4 PCIe x1 slots and 3 PCI slots

PE-13SD-R40

Mounting holes compatible with PCI-14S

Dual system

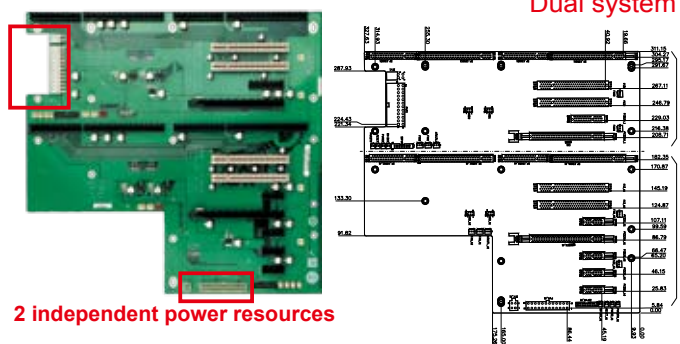

2 independent power resources

Ordering Information

- PE-13SD-R40 13 Slots Backplane with 2 PCIe x 16 and 1 PCIe x 4 and 4 PCIe x 1 and 4 PCI slot.
- RACK-3000G-R20 14-slot full-size industrial chassis
- RACK-305G-R20 14-slot full-size industrial chassis
- RACK-360G-R20 14-slot full-size industrial chassis
- RACK-814G-R20 14-slot full-size industrial chassis

PE-10S2-R40

Mounting holes compatible with PCI-14S

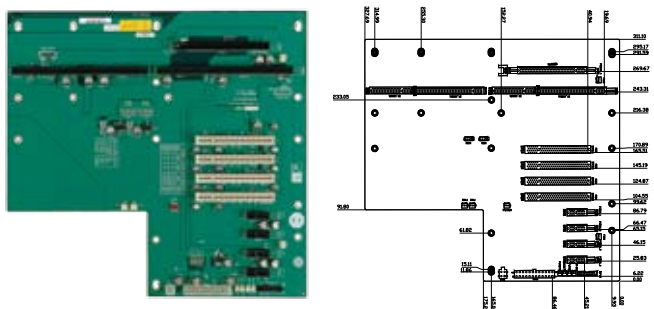

Ordering Information

- PE-10S2-R40 10-slot backplane with 1 PCIe x16 slot, 4 PCIe x1 slot and 4 PCI slots
- RACK-3000G-R20 14-slot full-size industrial chassis
- RACK-305G-R20 14-slot full-size industrial chassis
- RACK-360G-R20 14-slot full-size industrial chassis
- RACK-814G-R20 14-slot full-size industrial chassis

PE-16SQ-R10

Mounting holes compatible with PCI-18SQ

Quad system

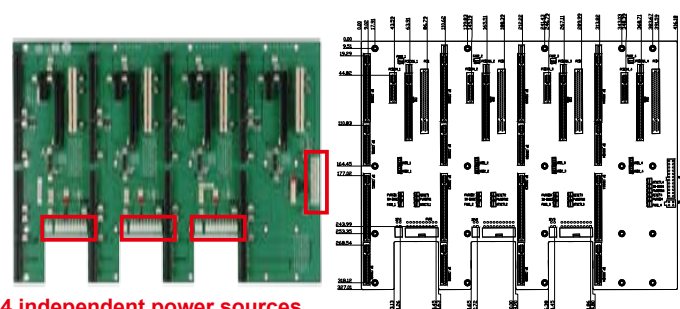

4 independent power sources

Ordering Information

- PE-16SQ-R10 4-system backplane with each system having 1 PCIe x16 slot, 1 PCIe x4 slot and 1 PCI slot
- RACK-4000-R20 4U 20-slot full-size industrial chassis

PXE-12S-R10

Mounting holes compatible with PCI-14S
(PCIe to PCI-X Bridge)

NEW

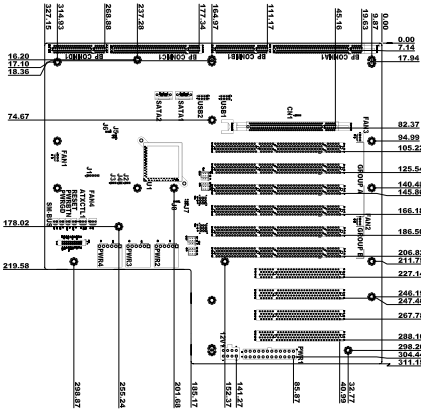

Ordering Information

- PXE-12S-R10 12-slot backplane with 1 PCIe x16 slot, 6 PCI-X slots and 4 PCI slots
- RACK-3000G-R20 14-slot full-size industrial chassis
- RACK-305G-R20 14-slot full-size industrial chassis
- RACK-360G-R20 14-slot full-size industrial chassis
- RACK-814G-R20 14-slot full-size industrial chassis

PXE-19S-R40

Mounting holes compatible with PCI-19S
(PCIe to PCI Bridge)

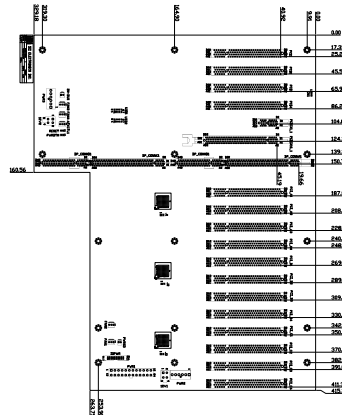

Ordering Information

- PXE-19S-R40 19-slot backplane with 1 PCIe x16 slot, 1 PCIe x1 slot and 16 PCI slots
- RACK-3200G-R20 4U 20-slot full-size industrial chassis
- RACK-3035G-R20 7U 20-slot full-size industrial chassis

PXE-13S-R42

Mounting holes compatible with PCI-14S
(PCIe to PCI-X Bridge)

NEW

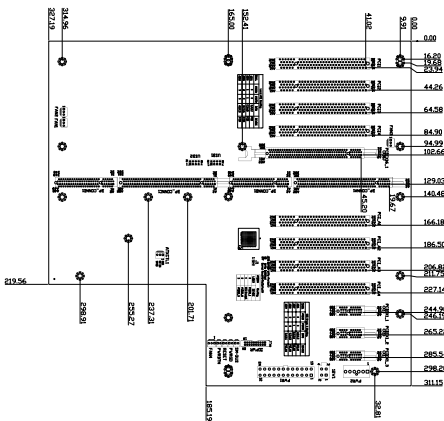

Ordering Information

- PXE-13S-R42 13-slot backplane with 1 PCIe x16 slot, 3 PCIe x1 slots and 8 PCI slots
- RACK-3000G-R20 14-slot full-size industrial chassis
- RACK-305G-R20 14-slot full-size industrial chassis
- RACK-360G-R20 14-slot full-size industrial chassis
- RACK-814G-R20 14-slot full-size industrial chassis

PXE-19S2-R10

Mounting holes compatible with PCI-19S
(PCIe to PCI Bridge)

NEW

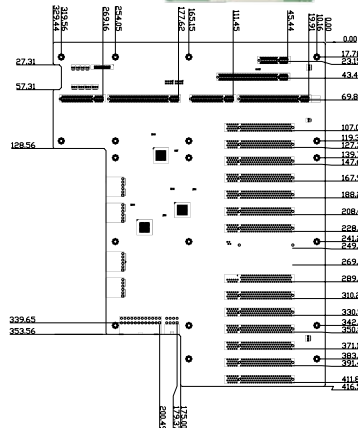

Ordering Information

- PXE-19S2-R10 19-slot backplane with 1 PCIe x16 slot, 1 PCIe x1 slot and 16 PCI slots
- RACK-3200G-R20 4U 20-slot full-size industrial chassis
- RACK-3035G-R20 7U 20-slot full-size industrial chassis