

# Industrial Intelligent Solutions

## 1 Introduction

Industrial Intelligent Solutions comprises four major parties which establish an elemental platform for enterprise data processing. By combining front-end data server/collector, universal data I/O communication and RISC-based data processing devices, IEI industrial intelligent solution provides an easy way to collect, transfer, process, access and manage data which is generated or inquired in various applications such as Factory Automation, Medical, Transportation management, POS, and Surveillance systems.

## RISC-based Solutions : The best platform for embedded system and Panel PC

	5.7"	7"	10.4"	15"
<b>Model Name</b>	IOVU-570M IOVU-571N	IOVU-700M IOVU-751R	IOVU-1000M IOVU-1051R	IOVU-1500M
<b>CPU</b>	Xscale® PXA 520MHz Winbond Nuvoton 200MHz	Xscale® PXA 520MHz Alchemy AU1250 500MHz	Xscale® PXA 520MHz Alchemy AU1250 500MHz	Xscale® PXA 520MHz Alchemy AU1250 500MHz
<b>Memory</b>	128MB	256MB	128MB	128MB
<b>Feature</b>	1. Compact form factor 2. Built-in WiFi 802.11b/g function	1. PoE available 2. MPEG 1/2/4 support 3. Built-in WiFi 802.11b/g function	1. The whole plane touch panel PC 2. Hardware decode MPEG 1/2/4, WMV9	1. Large display 2. Built-in digital input/ output function 3. Dual display function



	MIPS-based	ARM-based
<b>Model Name</b>	KAMIO-1251	KAMIO-2701A/2702A KAMIO-2703 KAMIO-CB01A
<b>CPU</b>	Alchemy AU1250 500MHz	Xscale PXA270 520MHz
<b>Feature</b>	Hardware decode MPEG 1/2/4, WMV9	1. 802.11b/g available 2. CF/SD card expandable 3. Wide temperature tolerance

## Data Collector Solutions : The best platform for PC-based server/data collector

	Intel® ULV Solution	AMD® solution	Marvell
<b>Model name</b>	VITO-2100 Series VITO-2688 VITO-2100-OPC310 Din-3000	VITO-2060 Series VITO-2070 Series	VITO-1000
<b>CPU</b>	Intel® Celeron® M	AMD LX800 AMD GX466	PXA270
<b>Feature</b>	1. PC-based Server/Controller 2. Easy to extend 3. Multi-port Server/Controller 4. High performance class	1. PC-based controller 2. Easy to extend 3. Multi-port controller 4. Affordable class	1. Easy to extend 2. Risc-based multi-port controller

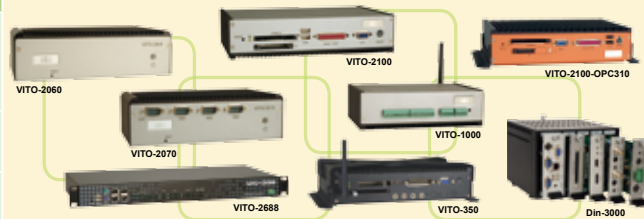

## Video Capture Solutions : The best platform for video/audio data capture

	Card Solution			Box Solution
	Software Compression	MPEG4 Hardware	Software Compression	
<b>Video Capture Controller</b>	Techwell TW6805	Conexant BT878A	Pentamicro/WIS	Techwell TW6805
<b>Model Name</b>	IVC-168G/268G IVCE-268G PM-6814/6844	IVC-100G-RS/200G-RS IVCE-8784 PM-1056	IVC-8371P IVC-368G-4CH PM-1059	VITO-350
<b>Feature</b>	1. Best Video Quality 2. Best fit in non-ideal signal 3. Low power consumption 4. Video/Audio Capture 5. No thermal 6. 7 fps DVR switch speed	1. Max Resolution degrees 2. Small video file size available 3. Most economic	1. CPU resource saving 2. Digital Watermark Security 3. DB25 connector available	1. Support 4-16 Video channels 2. Fanless architecture 3. Storage expendable 4. Direct image processing

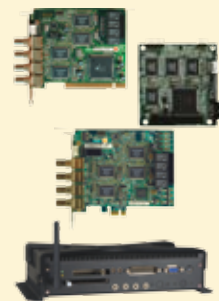

## I/O Communication Solutions : The best platform for diverse data communication

	RS232	CAN	DI/DO	RF
<b>Model Name</b>	PMS-400/400L/800/1200 PM-1004/1028-4/1028-8 PM-2004/2008	IPCI-1680 PM-1680	PM-3001/3002/3003/3004	PM-3008 (GSM/GPRS) IRFR-100 (HF RFID) IRFD-100 (HF RFID)
<b>Communication interface</b>	PCI/PCI-104	PCI/ PCI-104 PC/104	PCI/104	PC/104 USB Client (IRFR-100/IRFD-100)
<b>RS-232/422/485</b>	4/8/12 Com Ports	N/A	N/A	N/A
<b>CAN bus Ports</b>	N/A	2 ports	2 ports (PM-3001/3004)	N/A
<b>"Digital Input Digital Output"</b>	N/A	N/A	8/16 Digital Input 8/16 Digital Output	N/A

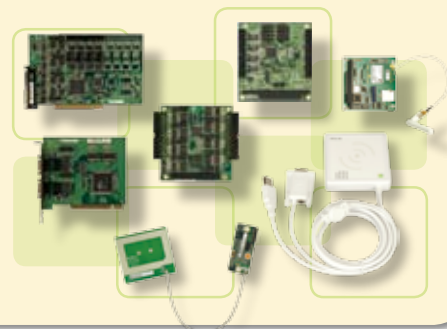

1

Industrial Computing Solutions

2

Embedded Computing Solutions

3

RISC-Based Embedded Solutions

4

Industrial Data Collector/Server Solutions

5

Video Capture Solutions

6

I/O Communication Solutions

7

Panel Solutions

8

Power Supply/Network Communication/Peripherals

# IOVU series PPC



**IOVU** (Input and Output Viewer) series enable the great embedded flexibility for RISC-based panel PC. Built with a XScale or Alchemy CPU, LCD display, touch screen, I/O peripherals, and pre-installed Windows® CE 5.0 or embedded Linux, the IOVU series provide the most cost-effective and stable solution for a diverse range of embedded RISC-based panel PC application. The supported software includes thin client technology, remote management tool, embedded OS SDK (software development kit) and BSP (board support package).

► Equipped with RISC CPU and Windows® CE embedded OS, the IOVU Series panel PCs are with high-performance computing power, fan-less design, low-power consumption, wide operating temperature, and wide-input-voltage range.

► The IOVU is designed for highly durable in harsh environments, due to its rugged, compact, low power consumption, and embedded system hardware design without failure-prone hard disk and fan. Each IOVU equips with a IP 65 or IP 64 compliant front panel to protect against accidental contacts of foreign bodies and against water.

► Each IOVU is driven by a powerful RISC CPU with built-in WDT (Watchdog Timer) functions, has a touch screen TFT display, and comes with a series of integrated external peripheral connectors including Ethernet ports, Serial ports, USB ports, Audio ports, CompactFlash™ slot, and optional wireless communication modules supporting WiFi 802.11 b/g, Bluetooth, GPS, or GSM/GPRS.



## MARVELL XScale® PXA270 and RMI Alchemy™ AU1250

High performance, ultra low power, lower cost, faster time-to-market, ARM V5TE compliant and robust tool chains make XScale® technology a compelling choice for applications ranging from smaller multimedia portable devices to high performance I/O or network applications.

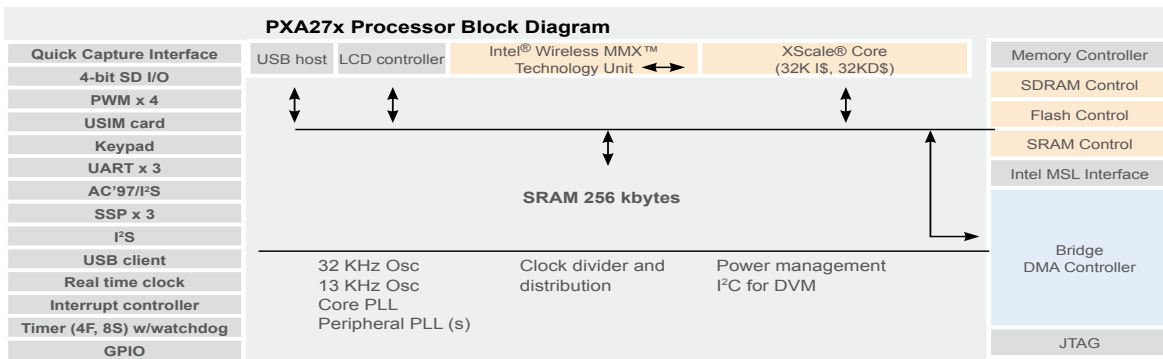

IEI provides RMI Alchemy™ RISC-based technology to enable users to play DVD quality video efficiently at full-frame rates with low power consumption. The integrated MAE (Media Acceleration Engine) supports common digital video media including MPEG1, 2, 4, DivX, and WMV9 scaled up to 1024 x 768 pixel resolution, and delivers full D1 resolution without the need for a DSP or specialized coding.

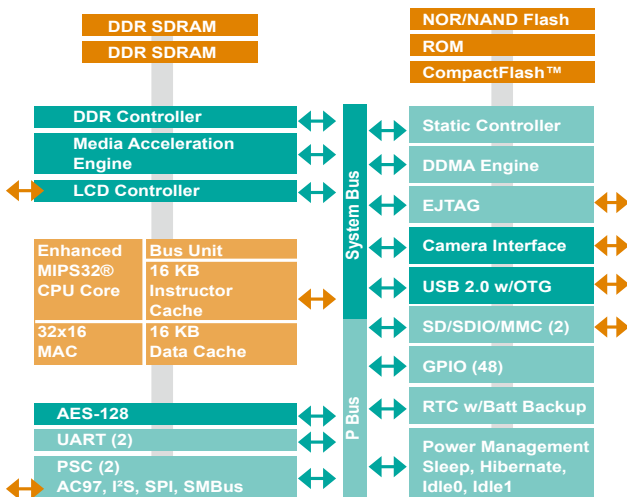

	XScale Technology	RMI	AMD Geode
	<b>XScale PXA270</b>	<b>Alchemy™ Au1250™</b>	<b>AMD® LX800</b>
CPU Speed	520MHz	500 MHz	500MHz
Companion Chipset	No need	No need	AMD® CS5536
Super I/O	No need	No need	Winbond W83627EHG
System Memory	SDRAM	DDR I/II	DDR
Multimedia Support	MPEG1/2 with Software codec	Built-in Hardware MAE	MPEG1/2 with Software codec
H.D.D I/F	CompactFlash™	IDE	IDE
LCD I/F	18-bit TTL	24-bit TTL	24-bit TTL
Power Consumption	747 mW	492 mW	4W
Working Temperature	-20°C ~ 85°C	-40°C ~ 100°C	0°C ~ 50°C or -10°C ~ 70°C
Embedded OS Support	Windows® CE and Embedded Linux	Windows® CE and Embedded Linux	Windows® XP/XPe/CE

# Software Support

## SDK (software development kit)

- Attached Software Development Kit (SDK) for eMbedded Visual C++ to program Windows® CE application.
- Built-in .NET Compact Framework support with related SDK
- Thin Client Technology, Microsoft RDP (Remote Desktop Protocol), to enable IOVU series to access Microsoft Windows® based applications installed on Microsoft Terminal Service server.
- Attached SDK including GUI, Sample Code, and Tool chain make users program application readily.

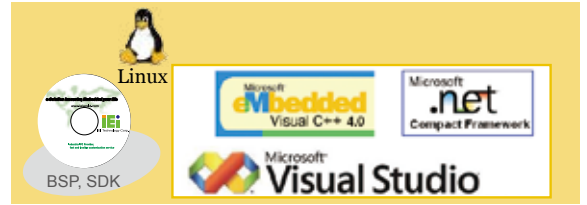

## IEI WinCE Utility

- Free pre-installed utilities for configuring and diagnosing your IOVU series panel PC

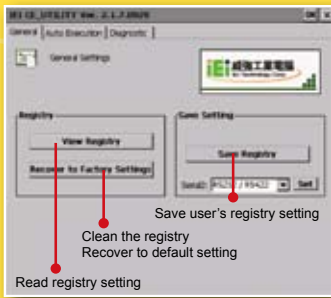

## RMT (Remote Management Tool)

- Free pre-installed utilities for configuring and diagnosing your IOVU series panel PC

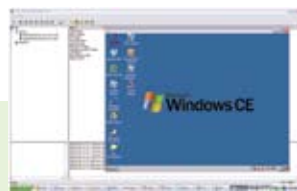

## BSP (Board Support Package)

### Linux Kernel 2.6.18

- GNU standard Embedded Linux 2,6,18 bootloader and OS image.
- Secure Shell (OpenSSH) providing 128-bit, 192-bit or 256-bit encryption between the IOVU series and another system
- Built-in web browser and X-window system
- Related Linux drivers for onboard peripheral I/O, network and audio
- Optional Board Support Package (BSP) includes kernel source code for customers to customize their own OS image.

### Embedded Linux Kernel configuration

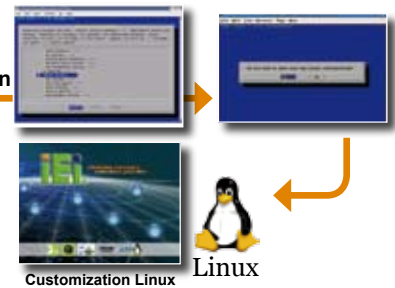

### Windows® CE5.0

- Standard Windows® CE5.0 professional version license.
- Optional Board Support Package (BSP) for customers to customize their own OS image.

### Windows® Platform Builder



1 Industrial Computing Solutions

2 Embedded Computing Solutions

3 RISC-Based Embedded Solutions

4 Industrial Data Collector/Server Solutions

5 Video Capture Solutions

6 I/O Communication Solutions

7 Panel Solutions

8 Power Supply/Network Communication/Peripherals

# Application

## Industrial Automation



## Power Monitoring, Power Demand Controller and Report Generator

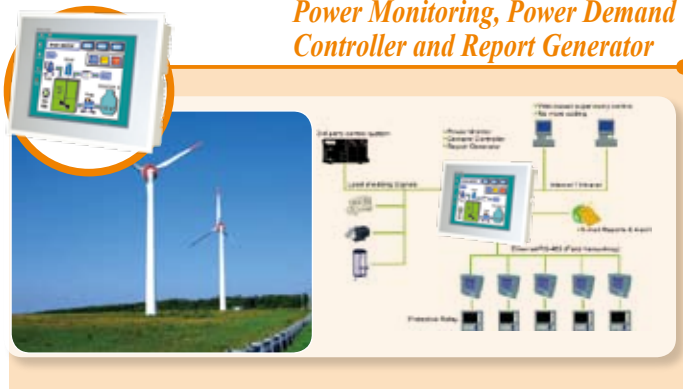

## Building Automation



## Vehicle PC



## Multi-media Applications



# Diversified Mounting Support and Rigorous Environmental test

IOVU series panel PC have several mounting holes compliant with the VESA mounting standard (VESA 75 / 100) on the rear panel for stand mounting and other mounting methods.

### Wall Mount

Requires no cut out in the wall surface. It mounts directly on the existing wall or desk.



### Panel Mount

Requires a cut out in the wall surface. With four clamps to tighten the screws that pass through the panel mounting clamps



## IP64 / 65 dustproof and waterproof front panel

The IOVU front panel is IP64 / IP65 compliant. IP64 / 65 compliance guarantees the front panel is dustproof and water-proof. The IOVU front panel can withstand any industrial environment where dust and drizzle is encountered.

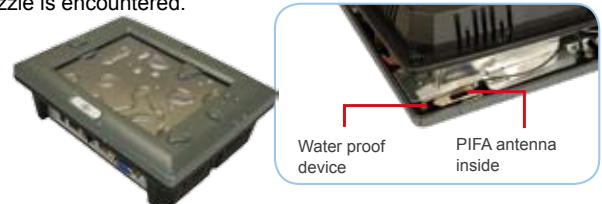

## Rugged design

The IOVU is directly mounted internally to a metal main frame rather than a fragile plastic cover. In addition, the IOVU case is made from ABS/PC (Acrylonitrile Butadiene Styrene/Polycarbonate Alloy), which improves the stiffness over conventional material and makes the system more solid and durable.



1 Industrial Computing Solutions

2 Embedded Computing Solutions

3 RISC-Based Embedded Solutions

4 Industrial Data Collector/Server Solutions

5 Video Capture Solutions

6 I/O Communication Solutions

7 Panel Solutions

8 Power Supply/Network/Communication/Peripherals

# IOVU RISC-based Panel PC specifications

NEW!!



NEW!!

POE  
NEW!!

Model Name	IOVU-570M	IOVU-571N	IOVU-700M	IOVU-1000M	IOVU-1500M	IOVU-751R	IOVU-1051R
<b>SYSTEM</b>							
CPU	XScale® PXA 520 MHz	Nuvoton (Winbond) W90P910CBG 200MHz	XScale® PXA 520 MHz	XScale® PXA 520 MHz	XScale® PXA 520 MHz	Alchemy AU1250 500 MHz	Alchemy AU1250 500 MHz
Bootloader Storage	2 MB	N/A	2 MB	2 MB	2 MB	2 MB	2 MB
RAM	128 MB SDRAM	128 MB SDRAM	256 MB SDRAM	128 MB SDRAM	128 MB SDRAM	256 MB DDR2	128 MB DDR2
OS/Program Storage	1GB Secure Digital card	64MB NAND flash	256MB Compact Flash card	128MB Compact Flash card	256MB Compact Flash card	1GB Secure Digital card	256MB Compact Flash card
<b>DISPLAY</b>							
LCD Size	5.7"	5.7"	7"	10.4"	15"	7"	10.4"
LCD Color	262 K	262K	262 K	262K	262K	262 K	262K
Display Resolution	VGA	VGA	WVGA	SVGA	XGA	WVGA	SVGA
LCD Brightness (cd/m <sup>2</sup> )	400	400	400	230	350	400	230
Dot Pitch (mm)	0.06(H) x 0.18(V)	0.06(H) x 0.18(V)	0.064(H) x 0.191(V)	0.264(H) x 0.264(V)	0.297(H) x 0.297(V)	0.064(H) x 0.191(V)	0.264(H) x 0.264(V)
Viewing Angle (H-V)	140 / 100	140/ 100	140 / 100	120 / 100	120 / 100	140 / 100	120 / 100
Backlight MTBF	25000	25000	50000	20000	50000	50000	20000
Touch Screne	Resistor Type	Resistor Type	Resistor Type	Resistor Type	Resistor Type	Resistor Type	Resistor Type
Multimedia Support	MPEG 1	MPEG 1	MPEG 1	MPEG 1	MPEG 1	MPEG 1/2/4 and WMV9	MPEG 1/2/4 and WMV9
<b>I/O and COMMUNICATION</b>							
I/O Interface	1 x RS-232/422/485 (software controllable) 2 x 10/100Mbps LAN 2 x USB1.1 host 1 x SD card slot 1 x Reset button 1 x On/Off power switch 1 x 2pin Terminal block power input	1 x USB2.0 host 1 x USB client 1 x SD card slot 1 x 10/100Mbps LAN 1 x RS-232 1 x RS-422/485 1 x On/Off power switch	1 x RS-422/485 (Software Controllable) 1 x RS-232 1 x 10/100Mbps LAN 1 x USB1.1 host 1 x Reset button 1 x On/Off power switch 1 x 2pin Terminal block power input 1set CAN bus	1 x RS-232/422/485 1 x RS-232 2 x 10/100Mbps LAN 2 x USB1.1 host 1 x Reset button 1 x On/Off power switch 1 x AC input (IOVU-1000M) 1 x 12V DC input (IOVU-1002M) 1 x 24V DC input (IOVU-1004M)	3 x RS-232/422/485 2 x 10/100Mbps LAN 2 x USB2.0 host 1 x Reset button 1 x On/Off power switch 8 x Digital output 1 x VGA output 1 x 2pin Terminal block power input	1 x RS-232/422/485 (Software Controllable) 1 x RS-232 2 x 10/100Mbps LAN 2 x USB2.0 host (one supports POE) 2 x USB1.1 host 1 x Reset button 1 x On/Off power switch 1 x 2pin Terminal block power input 1 x Power jack	1 x RS-232/422/485 1 x RS-232 2 x 10/100Mbps LAN 2 x USB1.1 host 1 x Reset button 1 x On/Off power switch 1 x AC input
Audio	1.5W Speaker	1 x Line-out	1.5W Speaker	1 x Mic-in, 1 x Line-out	1 x Line-out	1.5W Speaker	1 x Mic-in, 1 x Line-out
Wireless LAN	802.11 b/g	N/A	802.11 b/g	N/A	KAMIO-WL01 optional module (802.11 b/g)	N/A	N/A
<b>DIMENSION</b>							
Construction Material	ABS + PC Plastic	ABS + PC Plastic	ABS + PC Plastic	ABS + PC Plastic	Aluminum	ABS + PC Plastic	ABS + PC Plastic
Net Weight (kg)	0.7	0.8	0.85	2.62	4	0.8	2.62
Front Panel Colco	Cool Gray	Cool Gray	Cool Gray	Cool Gray	Sliver	Cool Gray	Cool Gray
Dimension (W x H x D mm)	180 x 135 x 45	180 x 132 x 40	226 x 140 x 41	312.5 x 242.6 x 68	410 x 309 x 85.2	226 x 140 x 41	312.5 x 242.6 x 68
<b>ENVIRONMENTAL / POWER</b>							
Operating Temperature (°C)	-20°C~60°C	0°C~50°C	-20°C~60°C	0°C~50°C	0°C~50°C	-20°C~60°C	0°C~50°C
Front Panel Protection	IP64 Compliant	IP64 Compliant	IP64 Compliant	IP65 Compliant	IP65 Compliant	IP64 Compliant	IP65 Compliant
Power Mode	AT	AT	AT	AT	ATX	AT	AT
Power Requirement	12~36 V DC-IN	9~28 V DC-IN	12~36 V DC-IN	100~240 V AC-IN	9~36 V DC-IN	6~30 V DC-IN	100~240 V AC-IN
Power Consumption	6 W	6 W	10 W	13 W	24W	8.5 W	13 W
Vibration and Shock	MIL-STD-810F 1. Axes: 3 axes (Vertical / Transverse / Longitudinal) 2. 10 ~ 500Hz, 60min/axis 3. Equivalent to Z: 2.18Grms, X: 1.6Grms, Y: 1.96Grms						
Humidity	5%-90%RH	5%-90%RH	5%-90%RH	5%-90%RH	5%-90%RH	5%-90%RH	5%-90%RH

1

Industrial Computing Solutions

2

Embedded Computing Solutions

3

RISC-Based Embedded Solutions

4

Industrial Data Collector/ Server Solutions

5

Video Capture Solutions

6

I/O Communication Solutions

7

Panel Solutions

8

Power Supply/ Network Communication/ Peripherals

# IOVU-1500M

## ARM-based Panel PC

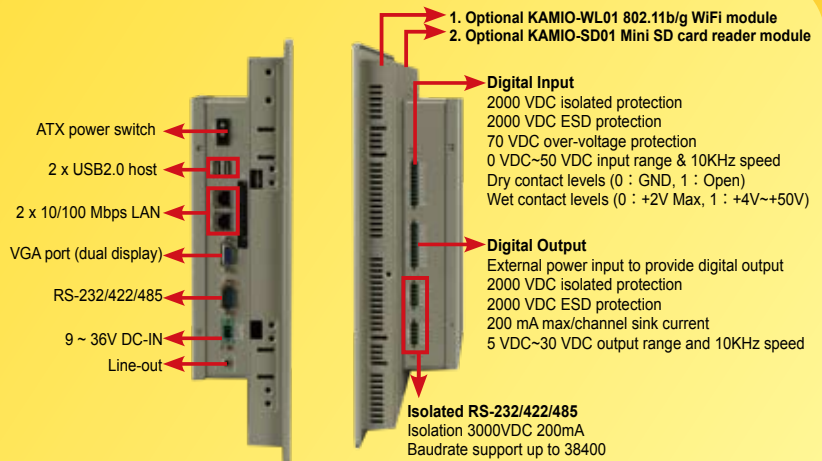

### Features:

- 15" TFT XGA LCD with resistive touch screen
- MARVELL XScale PXA270 520MHz processor and 128MB SDRAM
- Default 128MB CompactFlash card for OS and user data/programs
- IP65 compliant front panel
- Built-in Isolated Digital input/output
- Provide dual display function
- Fan-less design for rigorous environments
- Preinstalled Windows® CE5.0 operating system.
- Windows® CE5.0 SDK for user application software development

### Packing List

- 1 x IOVU-1500M
- 1 x Utility CD includes application tools, SDK, and technical document.
- 1 x Null modem cable
- 1 x Touch pen

### Ordering Information

Part No.	Description
IOVU-1500M-CE5/-R10	15", XGA fan-less touch panel PC with MARVELL XScale PXA270 CPU, 128MB SDRAM, built-in Windows® CE5.0 Operating System

### Options

Part No.	Description
KAMIO-WL01-R30	Wireless LAN module supports 802.11b/g
KAMIO-SD01-R10	Mini SD card reader module
AFLPK-15	Panel mount kit
AFLWK-19	VESA 100 wall mount kit
ARM-31-RS	LCD Monitor/PPC Arm kit loading capacity from 7kg~14kg
STAND-A19-RS	LCD Monitor/PPC Stand kit for VESA 100 and support up to 7.5 Kg
AFLP-12BMSR-U	USB Magnetic Card Reader
AFLP-BRW01-U / AFLP-BRB01-U	USB Barcode Reader (White / Black)
AFLP-CDB01 / AFLP-CDW01	VFD Customer Display (Green) 5 x 7 dot matrix (Black / White)
63000-FSP0601AD101C760-RS	12V DC 60W power adapter with bare wire, 90~264V AC input

### Dimensions (Unit : mm)

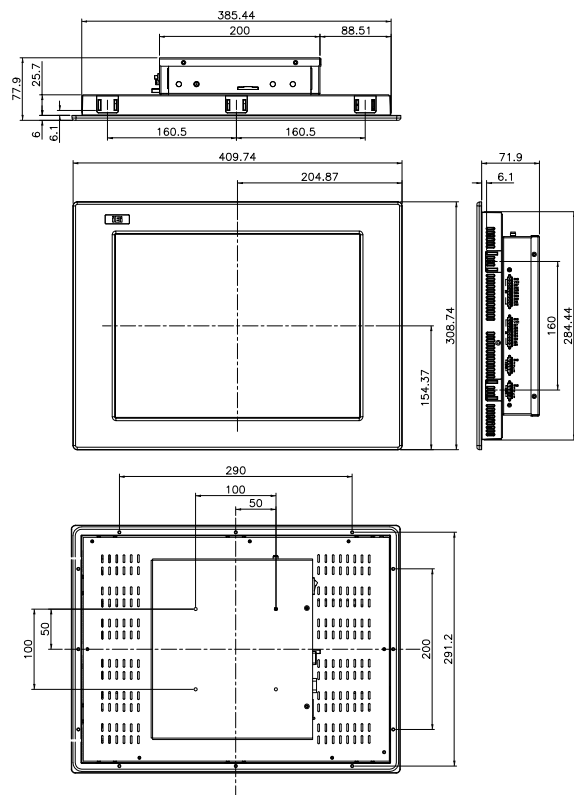

1

Industrial Computing Solutions

2

Embedded Computing Solutions

3

RISC-Based Embedded Solutions

4

Industrial Data Collector/Server Solutions

5

Video Capture Solutions

6

I/O Communication Solutions

7

Panel Solutions

8

Power Supply/Network/Communication/Peripherals

# IOVU-1000M

## ARM-based Panel PC

**The Whole Plane  
Touch Screen and  
IP65 compliant**



Preinstalled Windows® CE5.0 or ARM-Linux boot from CompactFlash card



CF card

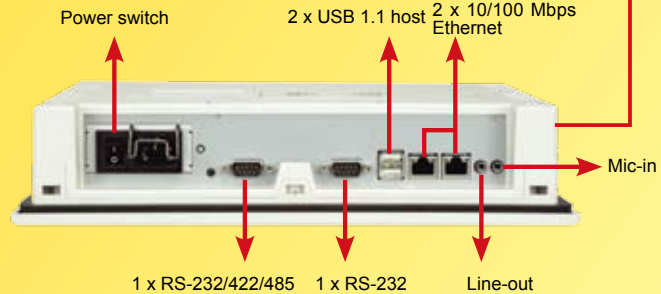

### Features:

- 10.4" TFT SVGA LCD with resistive touch screen
- MARVELL XScale PXA270 520MHz processor and 128MB SDRAM
- Default 128MB CompactFlash card for OS and user data/programs
- IP65 compliant front panel
- Fan-less design for rigorous environments
- Preinstalled Windows® CE5.0 operating system.
- Windows® CE5.0 SDK for user application software development

### Packing List

- 1 x IOVU-1000M
- 1 x Utility CD includes application tools, SDK, and technical document.
- 1 x Null modem cable
- 1 x Touch pen

### Dimensions (Unit : mm)

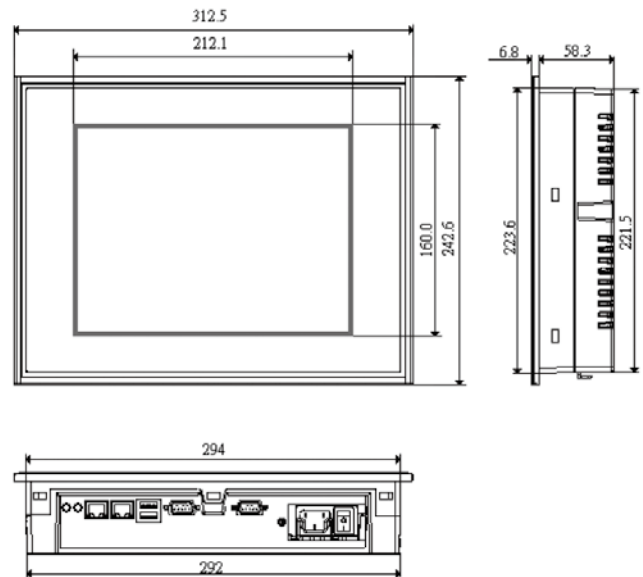

### Ordering Information

Part No.	Description
IOVU-1000M-CE5/R12	10.4", SVGA fan-less touch panel PC with MARVELL XScale® PXA270 CPU, 128MB SDRAM, and built-in Windows® CE5.0 Operating System, power type is AC input
IOVU-1002M-CE5/R12	10.4", SVGA fan-less touch panel PC with MARVELL XScale® PXA270 CPU, 128MB SDRAM, and built-in Windows® CE5.0 Operating System, power type is 12V DC input
IOVU-1004M-CE5/R12	10.4", SVGA fan-less touch panel PC with MARVELL XScale® PXA270 CPU, 128MB SDRAM, and built-in Windows® CE5.0 Operating System, power type is 24V DC input

1

Industrial Computing Solutions

2

Embedded Computing Solutions

3

RISC-Based Embedded Solutions

4

Industrial Data Collector/Server Solutions

5

Video Capture Solutions

6

I/O Communication Solutions

7

Panel Solutions

8

Power Supply/Network Communication/Peripherals

# IOVU-700M ARM-based Panel PC



Built-in WiFi function



WiFi function supports 802.11b/g

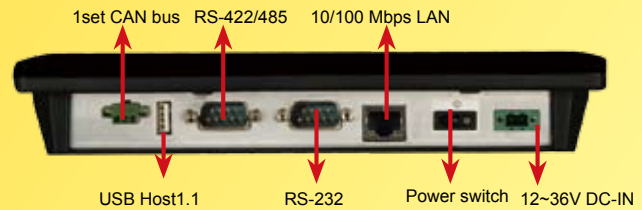

## Features:

- 7" TFT WVGA LCD with resistive touch screen
- MARVELL XScale PXA270 520MHz processor and 256MB SDRAM
- Default 256MB Compact Flash card for OS and user data/programs
- Internal WiFi controller provides 802.11b/g protocol
- Provide 1set can bus for industrial application
- Built-in 1.5W speakers
- IP64 compliant front panel
- Fan-less design for rigorous environments
- Preinstalled Windows® CE5.0 operating system
- Windows® CE5.0 SDK for user application software development

## Packing List

1 x IOVU-700M
1 x Utility CD includes application tools, SDK, and technical document.
1 x Null modem cable
1 x Touch pen

## Ordering Information

Part No.	Description
IOVU-700M-CE5/-R10	7", WVGA fan-less touch panel PC with MARVELL XScale PXA270 CPU, 256MB SDRAM, 802.11b/g WiFi function and built-in Windows® CE5.0 Operating System

## Dimensions (Unit : mm)

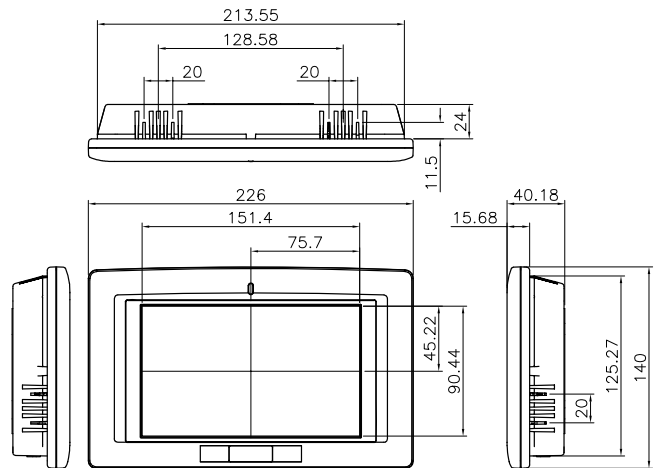

## Options

Part No.	Description
ALFPK-08	Panel mount kit
AFLWK-07	VESA 75 wall mount kit
ARM-11-RS	LCD Monitor/PPC Arm kit loading capacity from 3kg~7kg
STAND-A08-RS	LCD Monitor/PPC Stand kit for VESA 75 and support up to 5 Kg
VSTAND-A07	LCD Monitor/PPC STAND V type for VESA 75, 0~90 degree adjustable hinge and support up to 2.5 Kg
AFLP-12BMSR-U	USB Magnetic Card Reader
AFLP-BRW01-U / AFLPBRB01-U	USB Barcode Reader (White / Black)
AFLP-CDB01 / AFLP-CDW01	VFD Customer Display (Green) 5 x 7 dot matrix (Black / White)
63000-FSP0601AD101C760-RS	12V DC 60W power adapter with bare wire, 90~264V AC input

1 Industrial Computing Solutions

2 Embedded Computing Solutions

3 RISC-Based Embedded Solutions

4 Industrial Data Collector/Server Solutions

5 Video Capture Solutions

6 I/O Communication Solutions

7 Panel Solutions

8 Power Supply/Network/Communication/Peripherals



# IOVU-570M ARM-based Panel PC

**NEW**

## Built-in WiFi function



WiFi function supports 802.11b/g



SD card

Preinstalled Windows® CE5.0 or ARM-Linux boot from secure digital card

2 x USB1.1 host  
12~36 V DC-IN  
Reset button  
10/100Mbps LAN  
RS-232/422/485  
(software controllable)



## Features:

- 5.7" TFT VGA LCD with resistive touch screen
- MARVELL XScale PXA270 520MHz processor and 128MB SDRAM
- Default 1GB secure digital card for OS and user data/programs
- Built-in 802.11b/g Wireless LAN
- Built-in 1.5W speakers
- IP64 compliant front panel
- Fan-less design for rigorous environments
- Preinstalled Windows® CE5.0 operating system.
- Windows® CE5.0 SDK for user application software development.

## Packing List

1 x IOVU-570M
1 x Utility CD includes application tools, SDK, and technical document.
1 x Null modem cable
1 x Touch pen

## Ordering Information

Part No.	Description
IOVU-570M-CE5/-R10	5.7", VGA fan-less touch panel PC with MARVELL XScale PXA270 CPU, 128MB SDRAM, 802.11b/g wireless LAN and built-in Windows® CE5.0 Operating System

## Options

Part No.	Description
ALFPK-08	Panel mount kit
AFLWK-07	VESA 75 wall mount kit
ARM-11-RS	LCD Monitor/PPC Arm kit loading capacity from 3kg~7kg
STAND-A08-RS	LCD Monitor/PPC Stand kit for VESA 75 and support up to 5 Kg
VSTAND-A07	LCD Monitor/PPC STAND V type for VESA 75, 0~90 degree adjustable hinge and support up to 2.5 Kg
AFLP-12BMSR-U	USB Magnetic Card Reader
AFLP-BRW01-U / AFLPBRB01-U	USB Barcode Reader (White / Black)
AFLP-CDB01 / AFLP-CDW01	VFD Customer Display (Green) 5 x 7 dot matrix (Black / White)
63000-FSP0601AD101C760-RS	12V DC 60W power adapter with bare wire, 90~264V AC input

## Dimensions (Unit : mm)

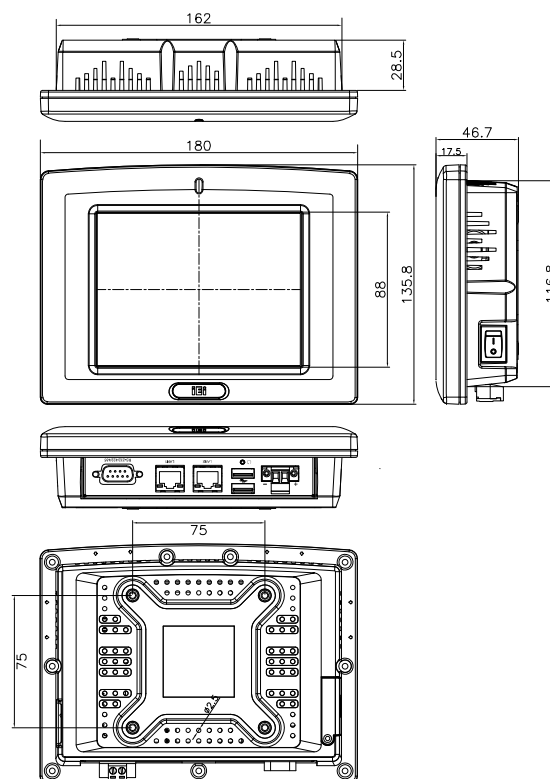

# IOVU-571N ARM-based Panel PC

**NEW**

## Features:

- Nuvoton(Winbond) W90P910CBG 200MHz processor
- low power consumption
- Fanless design for rigorous environments
- 5.7" TFT VGA LCD with resistive touch screen
- Standard peripheral device interface connectors include Ethernet, serial ports, SD, USB and Audio
- Preinstalled Windows® CE5.0 embedded operating system
- Windows® CE5.0 SDK for user application software development
- Default 128MB Flash for OS and user data/programs
- DC input +9V~+28V DC

## Packing List

- 1 x IOVU-571N
- 1 x Utility CD includes application tools, SDK, and technical document.
- 1 x Null modem cable
- 1 x Touch pen
- 1 x Screw kits

## Ordering Information

Part No.	Description
IOVU-571N-CE5/-R10	5.7" VGA fan-less touch panel PC with Winbond W90P910CBG CPU, 128MB SDRAM and built-in Windows® CE5.0 Operating System

## Dimensions (Unit : mm)

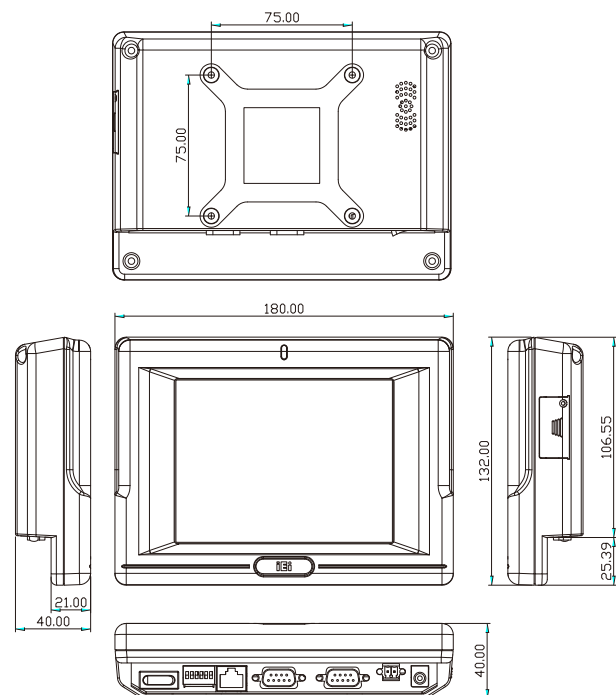

## Options

Part No.	Description
ALFPK-08	Panel mount kit
AFLWK-07	VESA 75 wall mount kit
ARM-11-RS	LCD Monitor/PPC Arm kit loading capacity from 3kg~7kg
STAND-A08-RS	LCD Monitor/PPC Stand kit for VESA 75 and support up to 5 Kg
VSTAND-A07	LCD Monitor/PPC STAND V type for VESA 75, 0~90 degree adjustable hinge and support up to 2.5 Kg
63000-FSP0601AD101C760-RS	12V DC 60W power adapter with bare wire, 90~264V AC input

# IOVU-1051R MIPS-based Panel PC



Preinstalled Windows® CE5.0 or ARM-Linux boot from CompactFlash card



CF card

**The Whole Plane  
Touch Screen and  
IP65 compliant**

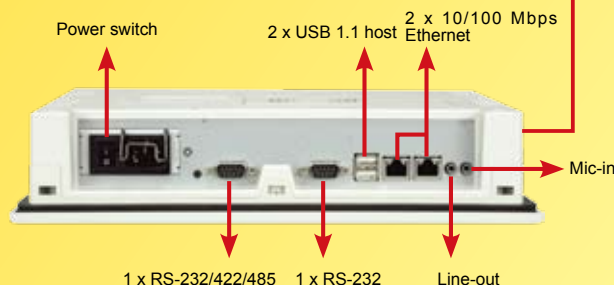

## Features:

- 10.4" TFT SVGA LCD with resistive touch screen
- RMI Alchemy™ AU1250 500MHz processor and 128MB DDR2 SDRAM
- Default 256MB CompactFlash card for OS and user data/programs
- Hardware decode MPEG1/2/4, and WMV9
- IP65 compliant front panel
- Fan-less design for rigorous environments
- Preinstalled Windows® CE5.0 operating system.
- Windows® CE5.0 SDK for user application software development

## Dimensions (Unit : mm)

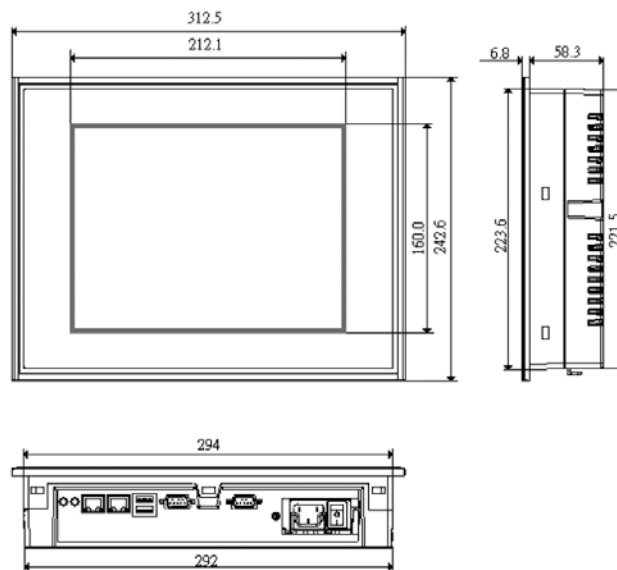

## Packing List

- 1 x IOVU-1051R
- 1 x Utility CD includes application tools, SDK, and technical document.
- 1 x Null modem cable
- 1 x Touch pen
- 1 x Screw kits

## Ordering Information

Part No.	Description
IOVU-1051R-CE5/-R10	10.4", SVGA fan-less touch panel PC with RMI Alchemy AU1250 CPU, 128MB DDR2 SDRAM, and built-in Windows® CE5.0 Operating System, power type is AC input.

1 Industrial Computing Solutions

2 Embedded Computing Solutions

3 RISC-Based Embedded Solutions

4 Industrial Data Collector/Server Solutions

5 Video Capture Solutions

6 I/O Communication Solutions

7 Panel Solutions

8 Power Supply/Network/Communication/Peripherals

# IOVU-751R MIPS-based Panel PC



**Power over Ethernet**

**NEW**



## Power Input Options

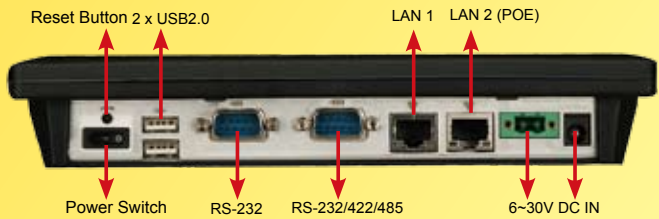
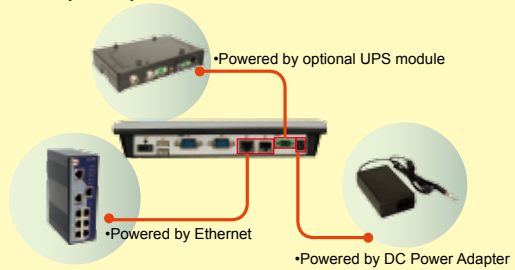

## Features:

- 7" TFT WVGA LCD with resistive touch screen
- RMI Alchemy AU1250 500MHz processor and 256MB DDR2 SDRAM
- Default 1GB secure digital card for OS and user data/programs
- Power over Ethernet (POE) function is compliant with 802.3af standard
- Hardware decode MPEG1/2/4, and WMV9
- Built-in 1.5W speakers
- IP64 compliant front panel
- Fan-less design for rigorous environments
- Preinstalled Windows® CE5.0 or ARM-Linux 2.6.18 operating system.
- Windows® CE5.0 or ARM-Linux SDK for user application software development

## Packing List

- 1 x IOVU-751R
- 1 x Utility CD includes application tools, SDK, and technical document.
- 1 x Null modem cable
- 1 x Touch pen

## Ordering Information

Part No.	Description
IOVU-751R-CE5/-R10	7", WVGA fan-less touch panel PC with RMI Alchemy AU1250 CPU, 256MB DDR2 SDRAM, LAN supports POE function and built-in Windows® CE5.0 Operating System
IOVU-751R-UX/-R10	7", WVGA fan-less touch panel PC with RMI Alchemy AU1250 CPU, 256MB DDR2 SDRAM, LAN supports POE function and built-in ARM-Linux 2.6.18 Operating System

## Dimensions (Unit : mm)

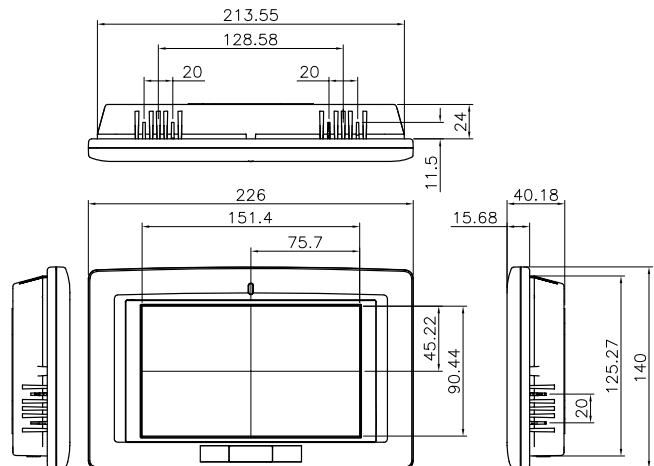

## Options

Part No.	Description
ALFPK-08	Panel mount kit
AFLWK-07	VESA 75 wall mount kit
ARM-11-RS	LCD Monitor/PPC Arm kit loading capacity from 3kg~7kg
STAND-A08-RS	LCD Monitor/PPC Stand kit for VESA 75 and support up to 5 Kg
VSTAND-A07	LCD Monitor/PPC STAND V type for VESA 75, 0~90 degree adjustable hinge and support up to 2.5 Kg
AFLP-12BMSR-U	USB Magnetic Card Reader
AFLP-BRW01-U / AFLPBRB01-U	USB Barcode Reader (White / Black)
AFLP-CDB01 / AFLP-CDW01	VFD Customer Display (Green) 5 x 7 dot matrix (Black / White)
63000-FSP0361 AD101C-RS	POWER ADAPTER, 90V-264V input and 12V/36W output; PLUG $\phi$ 2.5/ $\phi$ 5.5/no lock
63000-FSP0601 AD101C760-RS	12V DC 60W power adapter with bare wire, 90~264V AC input

# IOVU Aluminum series

## ARM-based Panel PC

### Features:

- 5.6"~8.4" TFT LCD with resistive touch screen
- MARVELL XScale PXA270 520MHz processor and 128MB SDRAM
- Default 128MB CompactFlash card for OS and user data/programs
- IP65 compliant front panel
- Fan-less design for rigorous environments
- Preinstalled Windows® CE5.0 operating system.
- Windows® CE5.0 SDK for user application software development.



IOVU-560



IOVU-650/WL



IOVU-700



IOVU-840

Model Name	IOVU-560	IOVU-650 / 650WL	IOVU-700	IOVU-840
<b>SYSTEM</b>				
CPU	XScale PXA 520 MHz			
Bootloader Storage	2 MB			
RAM	128 MB SDRAM			
OS/Program Storage	128 CompactFlash card			
<b>DISPLAY</b>				
LCD Size	5.6"	6.5"	7"	8.4"
Display Resolution	262 K	262K	262 K	262K
LCD Brightness (cd/m <sup>2</sup> )	500	500	350	450
Dot Pitch (mm)	0.118(H) x 0.362(V)	0.069(H) x 0.207(V)	0.1905 (H) x 0.1905 (V)	0.213 x 0.213
Viewing Angle (H-V)	100 / 60	140 / 120	140 / 100	130 / 110
Backlight MTBF	30000	30000	50000	50000
Touch Screne	Resistor Type	Resistor Type	Resistor Type	Resistor Type
Multimedia Support	MPEG 1	MPEG 1	MPEG 1	MPEG 1
<b>I/O and COMMUNICATION</b>				
I/O Interface	1 x RS-232/422/485 1 x 10/100Mbps LAN 2 x USB2.0 host 1 x CF card slot 1 x Reset button 1 x On/Off power switch 1 x 2pin Terminal block power input	1 x RS-232/422/485 1 x 10/100Mbps LAN 2 x USB2.0 host 1 x CF card slot 1 x Reset button 1 x On/Off power switch 1 x 2pin Terminal block power input 1 x MiniSD slot (IOVU-650WL)	4 x RS-232/422/485 (RJ-45 connector) 1 x RS-232 1 x 10/100Mbps LAN 2 x USB2.0 host 1 x Reset button 1 x On/Off power switch 1 x 2pin Terminal block power input	1 x RS-232/422/485 1 x RS-232 2 x 10/100Mbps LAN 2 x USB1.1 host 1 x Reset button 1 x On/Off power switch 1 x 12V DC-input
Audio	N/A	N/A	Line-out	1 x Mic-in, 1 x Line-out
Wireless LAN	N/A	802.11b/g (IOVU-650WL)	N/A	N/A
<b>DIMENSION</b>				
Construction Material	Aluminum	Aluminum	Aluminum	Aluminum
Net Weight (kg)	1.08	1.24	1.12	2.08
Front Panel Colco	Silver	Silver	Silver	Silver
Dimension (W x H x D mm)	166 x 126 x 48.63	169 x 129 x 49.2	197.2 x 136.3 x 52.1	243.6 x 177.6 x 55.1
<b>ENVIRONMENTAL / POWER</b>				
Operating Temperature (°C)	0°C~50°C	0°C~50°C	0°C~50°C	0°C~50°C
Front Panel Protection	IP65 Compliant	IP65 Compliant	IP65 Compliant	IP65 Compliant
Power Mode	ATX	ATX	ATX	AT
Power Requirement	9~36 V DC-IN	9~36 V DC-IN	9~36 V DC-IN	12 V DC-IN
Power Consumption	15 W	14 W	13 W	13 W
Vibration and Shock	MIL-STD-810F 1. Axes: 3 axes (Vertical / Transverse / Longitudinal) 2. 10 ~ 500Hz, 60min/axis 3. Equivalent to Z: 2.18Grms, X: 1.6Grms, Y: 1.96Grms			
Humidity	5%-90%RH	5%-90%RH	5%-90%RH	5%-90%RH

**Dimensions** (Unit : mm)

**IOVU-560**

**IOVU-650**

**IOVU-700**

**IOVU-840**

**Packing List**

- 1 x IOVU-560 / 650 / 650WL / 700 / 840
- 1 x Utility CD includes application tools, SDK, and technical document.
- 1 x 12V, 25W power adapter (only for IOVU-840)
- 1 x Null modem cable
- 1 x Touch pen

**Ordering Information**

Part No.	Description
<b>IOVU-560-R10</b>	5.6", QVGA fan-less touch panel PC with MARVELL XScale PXA270 CPU, 128MB SDRAM, built-in Windows® CE5.0 Operating System
<b>IOVU-650-R10</b>	6.5", VGA fan-less touch panel PC with MARVELL XScale PXA270 CPU, 128MB SDRAM, built-in Windows® CE5.0 Operating System
<b>IOVU-650WL-R10</b>	6.5", VGA fan-less touch panel PC with MARVELL XScale PXA270 CPU, 128MB SDRAM, built-in mini SD reader, 802.11b/g wireless LAN module and Windows® CE5.0 Operating System
<b>IOVU-700-R20</b>	7", WVGA fan-less touch panel PC with MARVELL XScale PXA270 CPU, 128MB SDRAM, built-in Windows® CE5.0 Operating System.
<b>IOVU-840-R12</b>	8.4", XGA fan-less touch panel PC with MARVELL XScale PXA270 CPU, 128MB SDRAM, built-in Windows® CE5.0 Operating System

**Options**

Part No.	Description
<b>AFLWK-07</b>	VESA 75 wall mount kit for IOVU-700 / 560
<b>AFLWK-19</b>	VESA 100 wall mount kit for IOVU-840 / 650
<b>STAND-A08-RS</b>	LCD Monitor/PPC Stand kit for VESA 75 for IOVU-700 / 560
<b>STAND-A19-RS</b>	LCD Monitor/PPC Stand kit for VESA 100 for IOVU-840 / 650
<b>63000-FSP0601</b>	12V DC 60W power adapter with bare wire, 90~264V AC input
<b>AD101C760-RS</b>	

- 1 Industrial Computing Solutions
- 2 Embedded Computing Solutions
- 3 RISC-Based Embedded Solutions
- 4 Industrial Data Collector/Server Solutions
- 5 Video Capture Solutions
- 6 I/O Communication Solutions
- 7 Panel Solutions
- 8 Power Supply/Network/Communication/Peripherals

# KAMIO series SBC



**KAMIO**  
RISC-based SBC

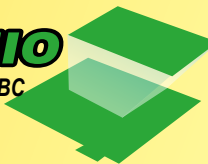

▶▶RISC (Reduced Instruction Set Computing) solutions use simpler instruction sets to achieve higher clock frequencies and process more instructions per clock cycle.

▶▶KAMIO series enable the great embedded flexibility for RISC-based platform. KAMIO provides high performance at low power consumption at a lower cost compared with typical X86 CISC (Complex Instruction Set Computing) processors applied to embedded applications.

▶▶Each KAMIO platform is driven by an powerful RISC CPU with built-in WDT (Watchdog Timer) functions, has a touch screen TFT display interface, and come with a series of integrated external peripherals.

▶▶Equipped with RISC CPU and Windows® CE or embedded Linux embedded OS, the KAMIO series are with high performance, fan-less design, low-power consumption, wide operating temperature, and wide-input-voltage range features.



## KAMIO series RISC SBC specifications



Model Name	KAMIO-1251	KAMIO-2701A / 2702A	KAMIO-2703	KAMIO-CB01A
CPU Socket	On-board	On-board	On-board	COM (CPU on module) (KAMIO-CM01A)
CPU Level	Alchemy AU1250 500 MHz	PXA270 520MHz	PXA270 520MHz	PXA270 520MHz
Boot ROM	2 MB	2 MB	2 MB	2 MB
RAM	128 MB DDR2	128 MB SDRAM	128 MB SDRAM	128 MB SDRAM
Storage Device	256 MB CompactFlash	256 MB CompactFlash	1GB Secure Digital card	256 MB CompactFlash
Max. Resolution	XGA	SVGA	SVGA	SVGA
LCD Interface	24-bit TTL and 18-bit LVDS	18-bit TTL and LVDS	18-bit TTL	18-bit TTL and LVDS
Multimedia Support	MPEG 1/2/4, WMV9	MPEG 1	MPEG 1	MPEG 1
I/O Interface	2 x USB2.0 host 1 x RS-232 1 x RS-232/422/485 2 x 10/100 Mbps LAN Mic-in x 1, Line-out x 1 4-wired resistive touch I/F Reset button	2 x USB1.1 1 x RS-232 1 x RS-232/422/485 2 x 10/100 Mbps LAN Mic-in x 1, Line-out x 1 4-wired resistive touch I/F Reset button	2 x USB1.1 1 x RS-232/422/485 (SW controllable) 2 x 10/100 Mbps Mic-in x 1, Line-out x 1 4-wired resistive touch I/F Reset button	2 x USB2.0 1 x RS-232/422/485 1 x 10/100 Mbps Mic-in x 1, Line-out x 1 4-wired resistive touch I/F Reset button
Wireless LAN	KAMIO-WL01 optional module (802.11b/g)	N/A	802.11b/g	KAMIO-WL01 optional module (802.11 b/g)
Operating Temperature	0°C~70 °C	-20°C~70°C	-20°C~70°C	-20°C~70°C
Power Requirement	5V and 12V DC-IN	5 V and 12 V DC-IN	12~36 V DC-IN	9~36 V DC-IN
Power Mode	AT	AT	AT	AT / ATX
Power Consumption	12 V @ 0.3 A	12 V @ 0.15 A	12 V @ 0.3 A	12 V @ 0.4 A
Dimension W x H (mm)	180 x 135.4	180 x 135.4	122.7 x 96	114 x 95
Humidity	5%-90%RH	5%-90% RH	5%-90%RH	5%-90%RH

1

Industrial Computing Solutions

2

Embedded Computing Solutions

3

RISC-Based Embedded Solutions

4

Industrial Data Collector/ Server Solutions

5

Video Capture Solutions

6

I/O Communication Solutions

7

Panel Solutions

8

Power Supply/ Network Communication/ Peripherals

# SDK (software development kit) and BSP (board support package)

## Software Support

KAMIO series is shipped with pre-installed Windows® CE 5.0 or Linux kernel 2.6.18, along with rich application software development kit :

### Windows® CE5.0

- Standard Windows® CE5.0 professional version license.
- Attached Software Development Kit (SDK) for eMbedded Visual C++ to program Windows® CE application.
- Built-in .NET Compact Framework support with related SDK
- Thin Client Technology, Microsoft RDP (Remote Desktop Protocol), to enable KAMIO series to access Microsoft Windows® based applications installed on Microsoft Terminal Service server.
- Free pre-installed IEI WinCE utility for configuring and diagnosing your KAMIO.
- Free IEI RMT (remote management tool) can be installed in your laptop for remotely configuring, monitoring, and managing your KAMIO platform.
- Optional Board Support Package (BSP) for customers to customize their own OS image.

Windows® Platform Builder



### Linux Kernel 2.6.18

- GNU standard Embedded Linux 2.6.18 bootloader and OS image including.
- Secure Shell (OpenSSH) providing 128-bit, 192-bit or 256-bit encryption between the KAMIO and another system
- Built-in web browser and X-window system
- Related Linux drivers for onboard peripheral I/O, network and audio
- Attached SDK including GUI, Sample Code, and Tool chain make users program application readily.
- Optional Board Support Package (BSP) including kernel source code for customers to customize their own OS image.

Embedded Linux Kernel configuration

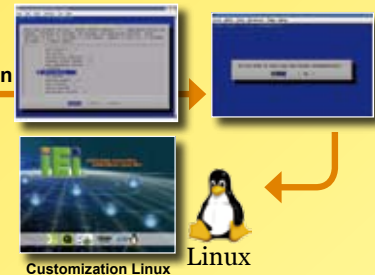

## Integration and Design for ODM/OEM

The KAMIO series embedded SBC have successfully to been integrated into a wide range of application devices such as LVDS/TTL TFT LCD panel, touch screen, storage device, RFID reader, barcode scanner, thermal printer, magnetic stripe card reader, battery solution, serial communication, wireless LAN, and POE (Power over Ethernet)...etc.

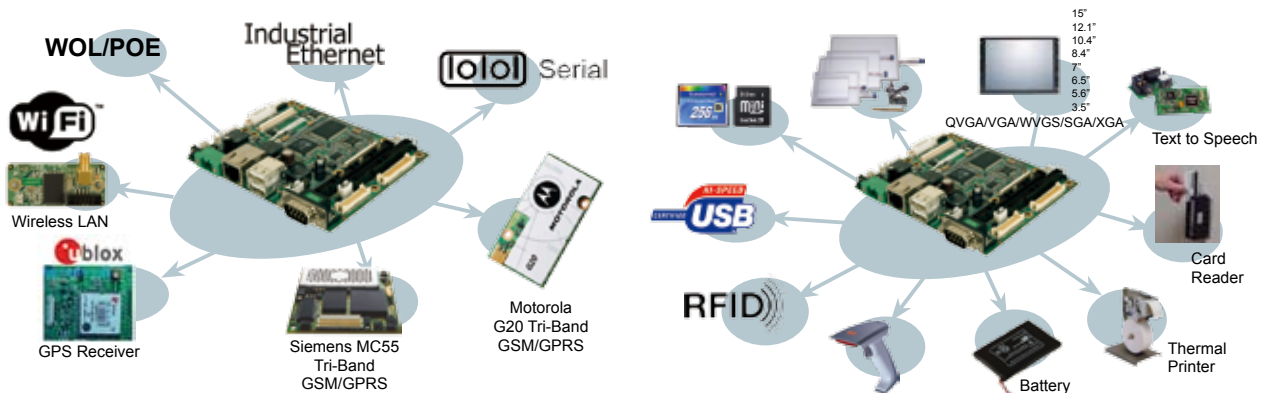

### System Customization

IEI provides a professional ID-design team designing to design chassis, front bezel and enclosure for practical and fashionable modeling.



2D/3D Gaming Machine Portable Device



Vehicle Entertainment System 2D/3D GPS Navigator



Automobile PC Telematics



Industrial Embedded Controller Data Collector



# KAMIO-1251 MIPS-based SBC



128MB SDRAM 18-bit LVDS LCD I/F      LCD inverter I/F      5V / 12V DC input

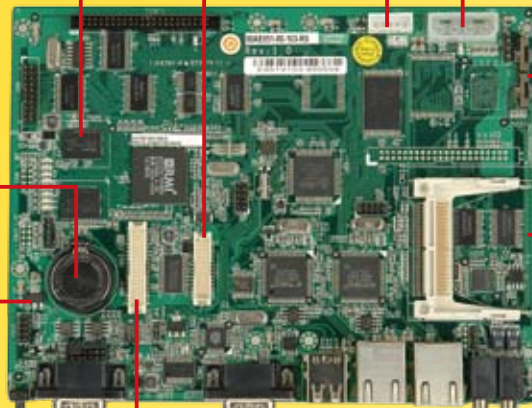

4-wired resistive touch I/F

Battery-backup RTC

Preinstalled Windows® CE5.0 or ARM-Linux boot from CompactFlash card

SDIO I/F can connect with KAMIO-WL01 WiFi module



**KAMIO-WL01**



**CF card**

24-bit TTL LCD I/F can connect with KAMIO-VGA01 TTL-to-VGA output module

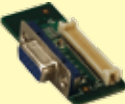

**KAMIO-VGA01**



## Features:

- RMI Alchemy AU1250 500MHz high performance processor with MAE (Media Acceleration Engine)
- Provide hardware decode for MPEG 1/2/4 and WMV9.
- Extremely durable in harsh environments.
- Compact form factor.
- Low power consumption.
- No cooling fan required.
- Built-in TTL and LVDS TFT LCD interfaces and touch controller.
- Standard peripheral device interface connectors include Ethernet, Serial, USB ports, CompactFlash memory, and audio.
- Preinstalled Windows® CE5.0 or Gnu/Linux with Rev2.6.18 kernel embedded operating system.
- Windows® CE5.0 SDK or ARM-LINUX\_GCC tool chain for user application software development.

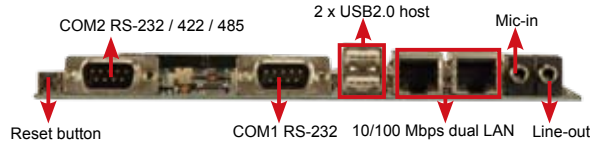

## Dimensions (Unit : mm)

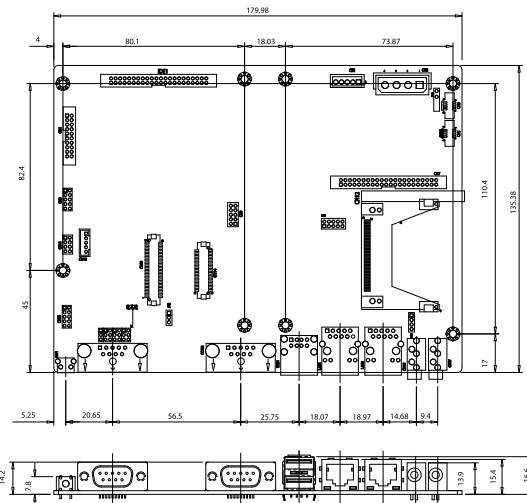

## Packing List

- 1 x KAMIO-1251 single board computer
- 1 x Utility CD includes application tools, SDK, and technical document
- 1 x 256MB CompactFlash card with built-in Windows® CE5.0 or ARM-Linux kernel Rev2.6.18

## Ordering Information

Part No.	Description
<b>KAMIO-1251-CE5/-R10</b>	RMI Alchemy AU1250 RISC-based embedded SBC with 256MB CompactFlash card and built-in Windows® CE5.0 OS
<b>KAMIO-1251-UX/-R10</b>	RMI Alchemy AU1250 RISC-based embedded SBC with 256MB CompactFlash card and built-in ARM-Linux kernel Rev2.6.18

## Options

Part No.	Description
<b>KAMIO-VGA01-R10</b>	LCD TTL interface to analog VGA output module
<b>KAMIO-WL01-R30</b>	Wireless LAN module supports 802.11b/g for KAMIO-1251-CE5/-R10 only.
<b>KAMIO-1251-CE5/BSP/-R10</b>	Windows® CE5.0 board support package for KAMIO-1251
<b>KAMIO-1251-UX/BSP/-R10</b>	Embedded-Linux kernel 2.6.18 board support package for KAMIO-1251

1 Industrial Computing Solutions

2 Embedded Computing Solutions

3 RISC-Based Embedded Solutions

4 Industrial Data Collector/Server Solutions

5 Video Capture Solutions

6 I/O Communication Solutions

7 Panel Solutions

8 Power Supply/Network/Communication/Peripherals

# KAMIO-2701A / 2702A ARM-based SBC

**XScale® General Purpose**

128MB SDRAM    18-bit LVDS LCD I/F    LCD inverter I/F    5V / 12V DC input

MARVELL XScale PXA270 520MHz Processor  
Battery-backup RTC

4-wired resistive touch I/F



**KAMIO-WL01 or KAMIO-SD01**

SDIO I/F can connect with KAMIO-WL01 WiFi module or KAMIO-SD01 Mini SD card reader module

Preinstalled Windows® CE5.0 or ARM-Linux boot from CompactFlash card



**CF card**



18-bit TTL LCD I/F can connect with KAMIO-VGA01 TTL-to-VGA output module

**KAMIO-VGA01**



## Features:

- MARVELL XScale PXA270 520MHz processor
- Extremely durable in harsh environments.
- Compact form factor.
- Low power consumption.
- No cooling fan required.
- Built-in TTL and LVDS TFT LCD interfaces and touch controller.
- Standard peripheral device interface connectors include Ethernet, Serial, USB ports, CompactFlash memory, and audio.
- Preinstalled Windows® CE5.0 or Gnu/Linux with Rev2.6.18 kernel embedded operating system.
- Windows® CE5.0 SDK or ARM-LINUX\_GCC tool chain for user application software development.

## Packing List

- 1 x KAMIO-2701A / 2702A single board computer
- 1 x Utility CD includes application tools, SDK, and technical document.
- 1 x 256MB CompactFlash card with built-in Windows® CE5.0 or ARM-Linux kernel Rev2.6.18

## Ordering Information

Part No.	Description
<b>KAMIO-2701A-CE5/-R10</b>	MARVELL XScale PXA270 RISC-based embedded SBC with 256MB CompactFlash card and built-in Windows® CE5.0 OS
<b>KAMIO-2702A-UX/-R10</b>	MARVELL XScale PXA270 RISC-based embedded SBC with 256MB CompactFlash card and built-in ARM-Linux kernel Rev2.6.18

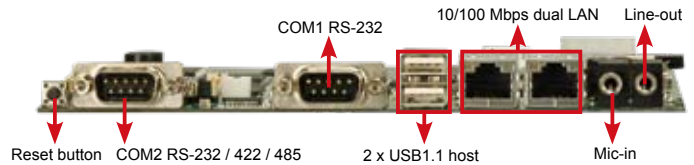

## Dimensions (Unit : mm)

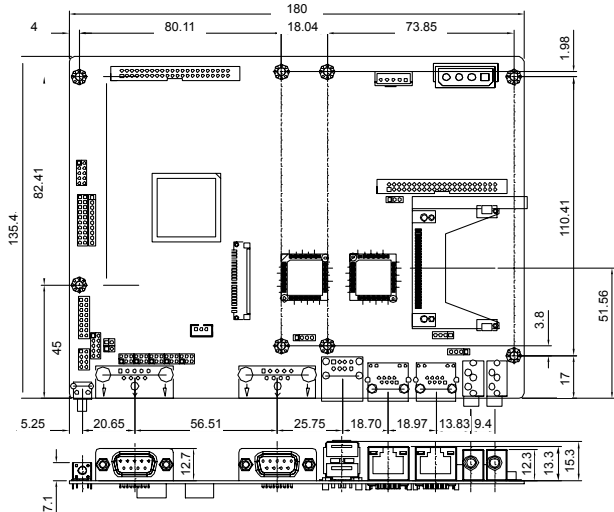

## Options

Part No.	Description
<b>KAMIO-VGA01-R10</b>	LCD TTL interface to analog VGA output module
<b>KAMIO-SD01-R10</b>	Mini SD card reader module
<b>KAMIO-WL01-R30</b>	Wireless LAN module supports 802.11b/g
<b>KAMIO-2701A-CE5/BSP/-R10</b>	Windows® CE5.0 board support package for KAMIO-2701A
<b>KAMIO-2702A-UX/BSP/-R10</b>	ARM-Linux kernel 2.6.18 board support package for KAMIO-2702A

# KAMIO-2703 ARM-based SBC

On-Board WiFi controller provides 802.11b/g protocol

18-bit TTL LCD I/F (40pin FPC connector)

JTAG debug port

128MB SDRAM

WiFi Antenna connector (IPEX type)  
32500-000500-RS  
32500-003300-RS

Mic-in

Speaker-out

4-wired resistive touch I/F

MARVELL XScale PXA270 520MHz Processor

Preinstalled Windows® CE5.0 or ARM-Linux boot from CompactFlash card

**Built-in WiFi function**  
WiFi function supports 802.11b/g

**SD card**



## Features:

- MARVELL XScale PXA270 520MHz processor
- Built-in WiFi controller provides 802.11b/g protocol
- Extremely durable in harsh environments.
- Compact form factor.
- Low power consumption.
- No cooling fan required.
- Built-in TTL TFT LCD interfaces and touch controller.
- Standard peripheral device interface connectors include Ethernet, Serial, USB ports, CompactFlash memory, and audio.
- Preinstalled Windows® CE5.0 embedded operating system.
- Windows® CE5.0 SDK for user application software development

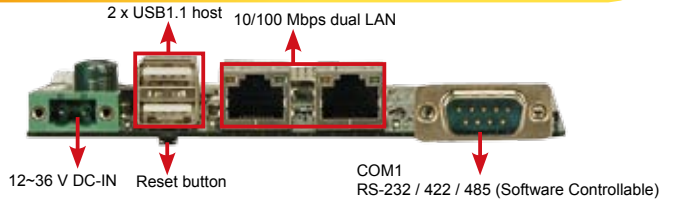

## Dimensions (Unit : mm)

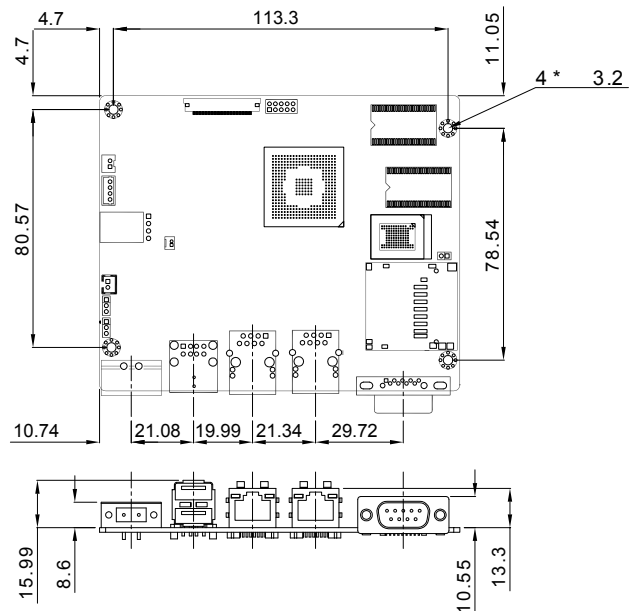

## Packing List

- 1 x KAMIO-2703 single board computer
- 1 x Utility CD includes application tools, SDK, and technical document
- 1 x 1GB Secure Digital card with built-in Windows® CE5.0

## Ordering Information

Part No.	Description
KAMIO-2703-CE5/R10	MARVELL XScale PXA270 RISC-based embedded SBC with 1GB Secure Digital card and built-in Windows® CE5.0 OS

## Options

Part No.	Description
32500-000500-RS	Wireless LAN Antenna 2.4GHz and 2.0dBi
32500-003300-RS	IPEX to SMA extended cable 200mm
KAMIO-2703-CE5/BSP/R10	Windows® CE5.0 board support package for KAMIO-2703

1 Industrial Computing Solutions

2 Embedded Computing Solutions

3 RISC-Based Embedded Solutions

4 Industrial Data Collector/Server Solutions

5 Video Capture Solutions

6 I/O Communication Solutions

7 Panel Solutions

8 Power Supply/Network/Communication/Peripherals

# KAMIO-CB01A / CM01A ARM-based SBC

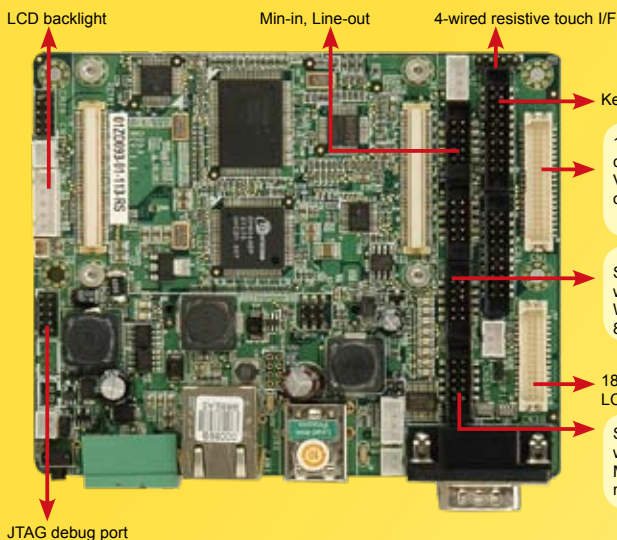

**XScale® COM**  
(computer on module)  
solution

**KAMIO-VGA01**

**KAMIO-WL01**

**KAMIO-SD01**



Preinstalled Windows® CE5.0 or ARM-Linux boot from CompactFlash card



**CF card**

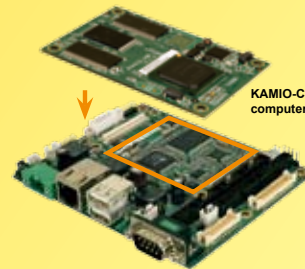

**KAMIO-CM01A**  
computer-on-module



## Features:

- MARVELL XScale PXA270 520MHz processor
- Board-to-Board CPU and I/O flexible application.
- Extremely durable in harsh environments.
- Compact form factor.
- Low power consumption.
- No cooling fan required.
- Built-in TTL TFT LCD interfaces and touch controller.
- Standard peripheral device interface connectors include Ethernet, Serial, USB ports, CompactFlash memory, and audio.
- Preinstalled Windows® CE5.0 or Gnu/Linux with Rev2.6.18 kernel embedded operating system
- Windows® CE5.0 SDK or ARM-LINUX\_GCC tool chain for user application software development.

## Packing List

KAMIO-CM01A	1 x KAMIO-CM01A CPU board (main board)
	1 x KAMIO-CB01A carry board (I/O function board)
KAMIO-CB01A	1 x Utility CD includes application tools, SDK, and technical document
	1 x CompactFlash card with built-in Windows® CE5.0 or ARM-Linux kernel Rev2.6.18

## Ordering Information

Part No.	Description
<b>KAMIO-CM01A-R10</b>	MARVELL XScale PXA270 RISC-based CPU board with Windows® CE5.0 bootloader for KAMIO-CB01A-R10
<b>KAMIO-CM01AUX-R10</b>	MARVELL XScale PXA270 RISC-based CPU board with Embedded Linux bootloader for KAMIO-CB01AUX-R10
<b>KAMIO-CB01A-01A-R10</b>	MARVELL XScale PXA270 RISC-based carry board for KAMIO-CM01A Computer-on-Module with 256MB CompactFlash card and built-in Windows® CE5.0 OS
<b>KAMIO-CB01A-01AUX-R10</b>	MARVELL XScale PXA270 RISC-based carry board for KAMIO-CM01A Computer-on-Module with 256MB CompactFlash card and built-in ARM-Linux kernel Rev2.6.18

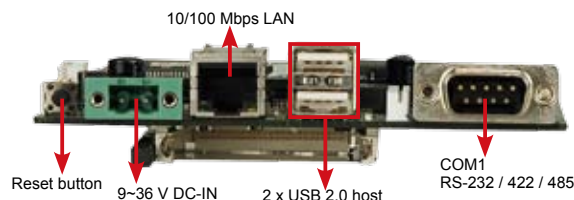

## Dimensions (Unit : mm)

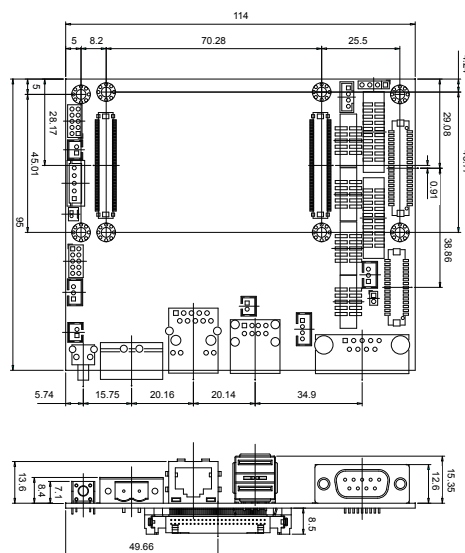

## Options

Part No.	Description
<b>KAMIO-VGA01-R10</b>	LCD TTL interface to analog VGA output module
<b>KAMIO-SD01-R10</b>	Mini SD card reader module
<b>KAMIO-WL01-R20</b>	Wireless LAN module supports 802.11b/g